

# HERITAGE<sup>®</sup>

BATHROOMS



*Design with Heritage*



Bathroom Design Inspiration  
and Product Guide



“**H**eritage Bathrooms are crafted in a time-honoured tradition. Each piece with a design heritage, engineered to meet modern needs.”

Quality is the key that ties everything together. The result? Well-designed products created to stand the test of time, in every sense.

Whether you have a large bathroom or smaller cloakroom, a period or modern property, you can mix and match all our products to create a space perfectly tailored to your desires and needs.

Turn the page to design with Heritage...

## Be inspired

Start your bathroom design journey with our on-trend decorating schemes – plus everything you need on how to get the look.

- 10 Pure and simple
- 18 Country house
- 26 Parisian chic
- 34 Colour splash
- 42 Plant power



## Discover the details

Stylish products and decorating ideas for your bathroom project.

- |                       |                             |
|-----------------------|-----------------------------|
| 16 Spa chic           | 41 Finishing touches        |
| 17 Mirror, mirror     | 48 Wake up and refresh      |
| 24 A splash of colour | 49 Pretty green             |
| 32 Keep it classic    | 50 Big ideas for tiny rooms |
| 40 Pure vanity        | 51 Colour schemes that work |

## Get the know-how

From making big decisions to the order of works, follow our top tips for managing a bathroom redesign.

- 54 Planning the space
- 55 Room to improve
- 55 Draw it up
- 56 Product focus
- 57 Need to know... Tile style

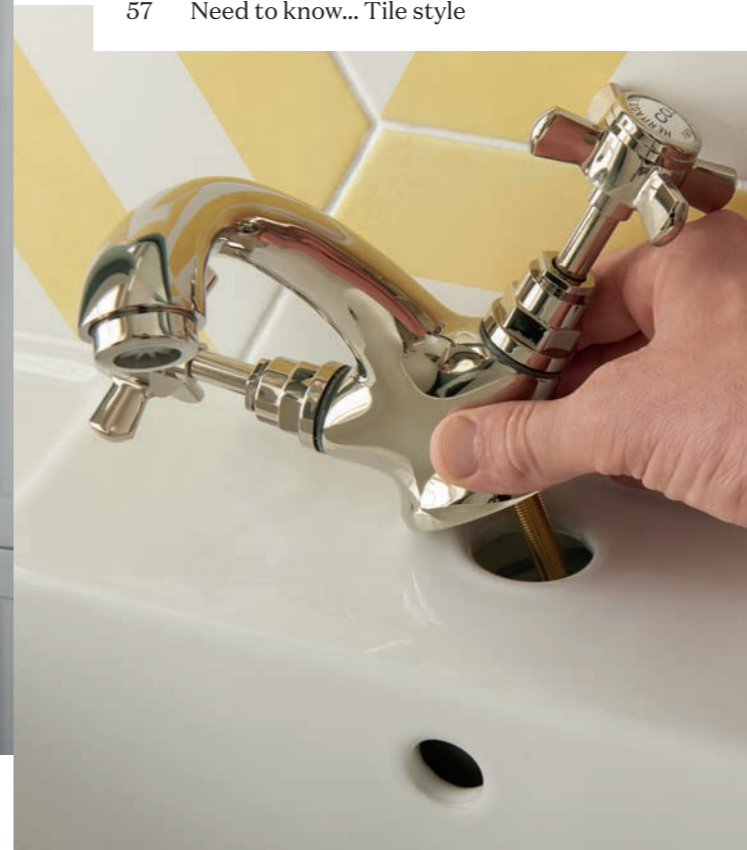

## Product selection

Our definitive guide to choosing the right fittings and accessories to suit your space.

- |                      |                        |
|----------------------|------------------------|
| 58 Furniture         | 174 Heated towel rails |
| 80 Sanitaryware      | 178 Product care       |
| 98 Baths             | 179 Water efficiency   |
| 122 Taps and showers | 180 Useful information |
| 158 Mirrors          | 182 Index              |
| 164 Accessories      | 184 Design planner     |

# Be inspired

Designing a bathroom can be daunting. We're making it simple. At Heritage, we have worked with a leading interior designer to bring you five very different bathroom looks, with suggested products to make it easy for you to design a bathroom that feels right for you.



**LOVE SOMETHING YOU SEE?**  
Turn to our product selector pages or visit [heritagebathrooms.com](https://heritagebathrooms.com) to find your local stockist.

# Inspiration to suit every style

Our five looks will take you through a wide range of our product and bathroom styles. From a bathroom that is bursting with colour, a room that is a serene retreat to an oasis full of plants, there is something for everyone. Our practical guides will help make the most of your space and turn your vision into reality.



Country House  
→ Page 18



Plant Power  
→ Page 42



**FIND A SHOWROOM**  
Our showroom partners have room displays so you can picture the designs in your home. Find your nearest showroom on our website [heritagebathrooms.com](https://heritagebathrooms.com)

Pure and Simple  
→ Page 10



Colour Splash  
→ Page 34



Parisian Chic  
→ Page 26

LOOK N° 1

# Pure and simple

Where less is most definitely more, this blissed-out bathroom is a vision of practicality, order, and calm.



**SUITE VARIETY**

Choose a look and select products from across our carefully curated range.

S

Sinking back into a beautiful bath for a relaxing soak after a stressful day is wonderful. This spa style bathroom hits all the unfussy and comforting style notes.

Curved lines and rounded shapes add a feeling of sensuality and welcome relaxation. The sanitaryware is kept simple, as much to do with aesthetics as it is with utility. Our freestanding Pomeroy bath and Stamford toilet are free of anything unnecessary, making them beautiful to look at and easy to clean.



Stamford toilet  
→ Page 94



Pomeroy  
Freestanding bath  
→ Page 110

*Our Lynton range has been thoughtfully designed to store your bathroom essentials.*



Lynton wall hung  
vanity unit 800mm  
→ Page 70

PURE AND SIMPLE

# Create *the look*

Circular LED-lit mirrors, glass accessories and Japanese influences add modernity to this classic bathroom. A freestanding bath always makes a bathroom feel luxurious and as storage is a key factor, our Shaker-style Lynton vanity unit is perfect for hiding bottles and accessories. Hung from the wall, it creates the illusion of space. The walls are painted in soft cream and stone shades, given an edge with a shower and taps in chrome. All in all, it is a dreamy space to start and end the day.



Pomeroy freestanding bath → Page 110

**FEEL SERENE**  
All Heritage baths are made to the highest standards and come with a 25 year guarantee.



For our full range of accessories go to → Page 164

Salcombe Basin Mixer → Page 142



Salcombe Floor Standing Bath Shower Mixer → Page 143



1. Japanese-style bamboo pendant light from H&M. 2. Set of white waffle towels from Secret Linen Store. 3. Heritage 'Newick' mirror. Find it on page 158. 4. Collection of vintage glass bottles from Etsy.com 5. Complete Bliss Hand & Body Wash from Neom. 6. Ash Wood Towel ladder from Dunelm. 7. Butterfly stool from Vitra.



Stamford Toilet → Page 94



Lynton wall hung vanity unit 800mm → Page 70



Portland floor mounted Towel warmer in vintage gold → Page 176





## THE RETREAT

# Spa chic

### 10 product ideas for a serene bathing space

1. Choose a curved, freestanding bath that cocoons the body. See page 104.
2. Wall-mounted toilets (page 88) are great for small spaces and easy on the eye.
3. Comfort is paramount. If space allows, add a chair or stool.
4. Fixtures, fittings, and materials are an investment. Choose what you love.
5. Position a bath by a window facing towards the garden.
6. Consider real wood which is warm to walk on or underfloor heating for tiles.
7. Low level lighting creates a relaxed look. Dimmer lights are your go-to here.
8. Plants are guaranteed to lift the spirits. See page 42 for green inspiration.
9. Hide clutter in beautiful storage. See page 50 for ideas.
10. Lighting a candle is a quick and easy route to bathroom bliss.



## THE ESSENTIALS

# Mirror, mirror

Whether you're upgrading an existing bathroom or putting in a whole new suite, good lighting is essential – and by that we mean mirrors. Round or rectangular, our curved-edge mirrors will make a space feel bright and inviting. It's what you do with them that counts. A large mirror will trick the eye by enlarging a room.

Our range of LED mirrors are available in chrome, gold and black finishes and include features that prevent the mirror from misting when the hot shower is on. And with practicality in mind, they can also switch between cool or warm white light. For an extra stylish touch, our Amberley mirror is hung from a leather-look strap for that Scandinavian feel.

See page 158-163 for our full range.

LOOK N° 2

# Country house

An English country house blend of old and new, this bathroom may be traditional, but it is far from old-fashioned.



**LIGHT WORK**  
Our Newick mirror blends contemporary styling with integrated LED lighting.



*Our Tilbury acrylic bath fits neatly into corners, allowing for the addition of a shower screen.*

# R

Rooms filled with ditsy floral wallpaper, beautiful furniture, and patterned textiles – there’s no denying that a Victorian-inspired look is desirable.

To keep the look up to date, it’s all in the mix. If it is stylish and practical, it goes. To keep the look up to date, invest in a hero or two, such as our Wilton vanity unit and Tilbury claw foot bath. With its clever design that fits neatly into corners, the bath allows for the addition of a shower screen. Perfect for busy families.

Dorchester Comfort height pan & landscape cistern → Page 92



Trinity Exposed Dual Control Shower → Page 149



Clifton Towel Warmer → Page 176

COUNTRY HOUSE

# Create *the look*

How to bring a modern, unstuffy twist to a traditional look? Colour is key. Stick to vivid shades rather than faded. Combine old with new. The Newick mirror contrasts stylishly with the Tilbury bath. Wallpaper adds a lot to the room with patterns mixed gladly. For instance, a Berber rug works well with florals or stripes. Be brave and mix styles: painterly portraits that contrast with line drawings and vintage dinnerware. A wooden floor and tongue-and-groove panelling add to the country look.



Tilbury Corner Freestanding Acrylic Bath  
→ Page 113



Trinity Bath Filler  
→ Page 146



Trinity Basin Mixer  
→ Page 146



Clifton Towel Warmer  
→ Page 176



Dorchester Comfort height pan & landscape cistern  
→ Page 92



Broughton Vanity unit and Worktop  
→ Page 64

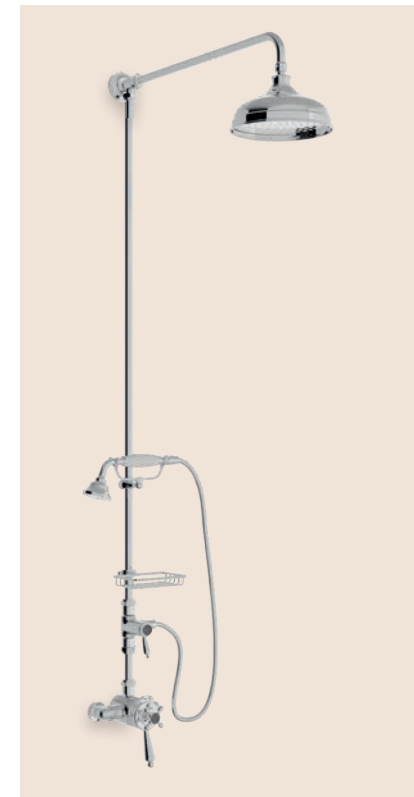

Trinity Exposed Dual Control Shower  
→ Page 149



1

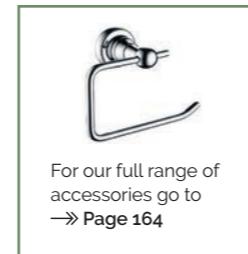

For our full range of accessories go to  
→ Page 164



2



3



4



5

1. 'Karim' rug from Graham & Green. 2. Hand soap from Austin Austin. 3. 'Marguerite' Green/Ivory Wallpaper from Jane Clayton & Co. 4. Framed art from Anthropologie. 5. Pair of Drake arm wall lights and ikat shades from Pooky.



THE PAINTED BATH

# A splash of colour

Matching the desire for bespoke finishes, our cast iron baths can be painted to add colour to your space. Paired with striking ball and claw feet, this gives you the chance to create your own stylish individual look.

Arriving primed and ready to paint you can choose any shade for the exterior, and if you want to update the colour when you redecorate, or quick refresh, just add a quick lick of paint.



Devon  
Cast Iron Bath  
→ Page 103



**DID YOU KNOW?**  
Heritage is the UK's market leader for cast iron baths. Designed to last, our baths have a lifetime guarantee.



Essex  
Cast Iron Bath  
→ Page 103

Buckingham  
Cast Iron Bath  
→ Page 102

LOOK N° 3

# Parisian chic

How to decorate like a Parisian: statement vanity unit, flattering colours, and a graphic tiled floor.



**HERO PIECES**  
A beautiful bath and vanity unit are important investments for maximum comfort and practical use.

Glastonbury Swivel Spout Basin Mixer  
→ Page 134



Stanmer LED Mirror  
→ Page 163

T

The French are known for a classic style with a modern twist. At its most glamorous, this mood is brought to life by mixing timeless pieces such as the Buckingham bath and Wilton vanity unit with graphic patterned tiles. The bolder the better. One thing a bathroom should always have is a mirror. Our LED Stanmer design provides bright light and creates the illusion of space. Our elegant Glastonbury taps and shower mixers and Cabot towel warmer add to the look. A plaster ceiling rose or frieze? Even the smallest of rooms can be grand.

*One thing a bathroom should always have is a mirror. The Stanmer provides bright light and creates the illusion of space.*



Granley Toilet  
→ Page 93



Buckingham Cast Iron Bath  
→ Page 102

Glastonbury Bath Shower Mixer  
→ Page 134



PARISIAN CHIC

# Create *the look*

Voila! How to bring Gallic chic to a Victorian townhouse or a modern family home? Art Deco-influenced lighting, geometric-patterned floor tiles and ornate plaster corning all add to the transformation – made modern against a palette of navy, duck-egg blue and sage green. Graphic tiles bring the character. Our Stanmer rectangular mirror, hung alone or as a pair, will maximise on light. The Wilton vanity unit with its marble-effect top adds grandeur as well as useability – making the most of the space with everything tucked away.



**DID YOU KNOW?**

Every cast iron bath is a blank canvas, finished with a paintable exterior so you're free to tailor the look however you please.

**CAST IRON GUARANTEE**

When choosing a bath, durability is key. Our cast iron baths feature white enamel interiors and are primed with undercoat, ready to paint.

Buckingham Cast Iron Bath  
→ Page 102

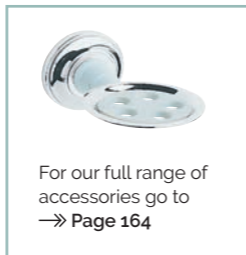

For our full range of accessories go to  
→ Page 164

Glastonbury Swivel Spout Basin Mixer  
→ Page 134



Glastonbury Bath Shower Mixer  
→ Page 134



Granley Toilet  
→ Page 93



Wilton Curved Single Vanity Unit  
→ Page 72

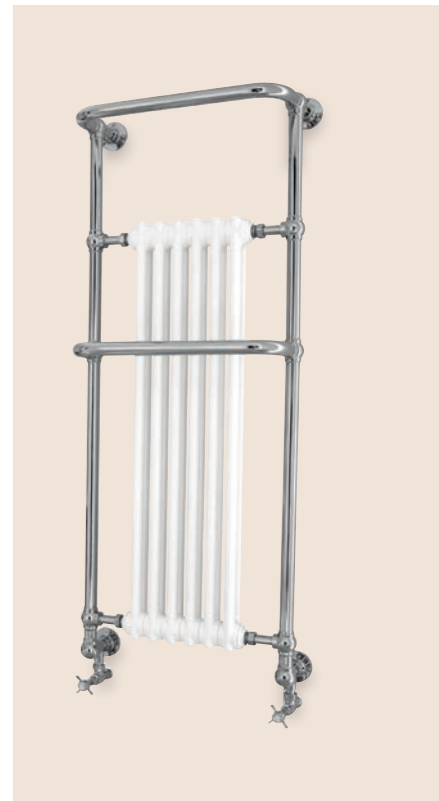

Cabot Towel Warmer  
→ Page 177



1. Mint Satin Kimono from Muse & Moda. 2. Pair of 'Jewel' side light from Leader Lights. 3. Fluted Side table from Westelm. 4. Green glass vase from Barker & Stonehouse. 5. Detangling Conditioner from Typology Paris. 6. Heritage 'Stanmer' illuminated mirror. Find it on page 163.





Glastonbury Bath Shower Mixer  
→ Page 134

## THE FINISHES

# Personalise everything

In the bathroom, every material choice - from the taps and shower roses to vanity tops and floors - is an opportunity to express yourself, so consider the finished look and the effect you would like to achieve.

Brushed nickel, brushed brass and matt black a great alternatives to chrome. They ooze elegance and add just the right amount of interest to any scheme. Unlike the shininess of chrome, a brushed or matt finish softens anything from looking too minimal and sleek. Plus, they're tactile too. Combined with marble and patterned tiles, the look reads warm and sophisticated.

Our comprehensive range of taps, as well as luxury showers, illuminated mirrors and bathroom accessories, come in a variety of colours, finishes and styles. The smartness of chrome to burnished brass beauties are available across pretty much everything, even the smallest of finishing touches like furniture handles and overflows.



Salcombe Basin Mixer Tap  
→ Page 142



Lullington Robe Hook  
→ Page 172



Glastonbury Swivel Spout Basin Mixer  
→ Page 134

LOOK N° 4

# Colour splash

Highlight your bathroom with colour and pattern. The mood is bright, happy, and designed for family life.



**ANYTHING GOES**  
Our products are carefully designed to work together. Here, one of our practical fitted baths is paired with our Hatton basin and toilet.

Dawlish  
Recessed shower  
→ Page 131



*As an alternative to chrome,  
our gold finish adds a touch  
of warm, happy brightness.*

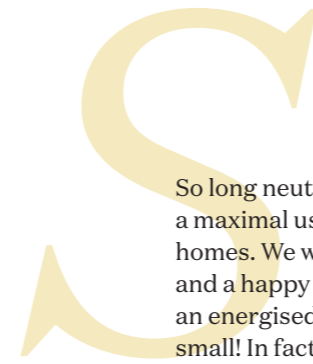

So long neutrals. There's a swing towards a maximal use of colour and pattern in our homes. We want to feel more optimistic, and a happy bright bathroom will inspire an energised state of mind. No space too small! In fact, a downstairs loo or ensuite is the perfect spot to go as vibrant as you like. Adding to the glow, many of our shower mixers and taps are available in a gold finish to suit your bathroom interior.

Hatton basin  
→ Page 89



Hatton Standard  
Height CC Pan  
→ Page 95



Dawlish Basin mixer  
→ Page 130



COLOUR SPLASH

# Create *the look*

Play with colour and pattern to transform even the smallest space. This bathroom features a variety of prints such as floral textiles and beehive-patterned stripes. The yellow, white, and blue colour scheme brightens the room even further and is eye-catching against a simple bathroom suite. Practical, stylish, and incredibly good value, our Hatton collections are the perfect starting point and go with cute 1950s Modernist furniture as well as they do with brand new.



For our full range of accessories go to  
→ Page 164

Dawlish Basin mixer  
→ Page 130

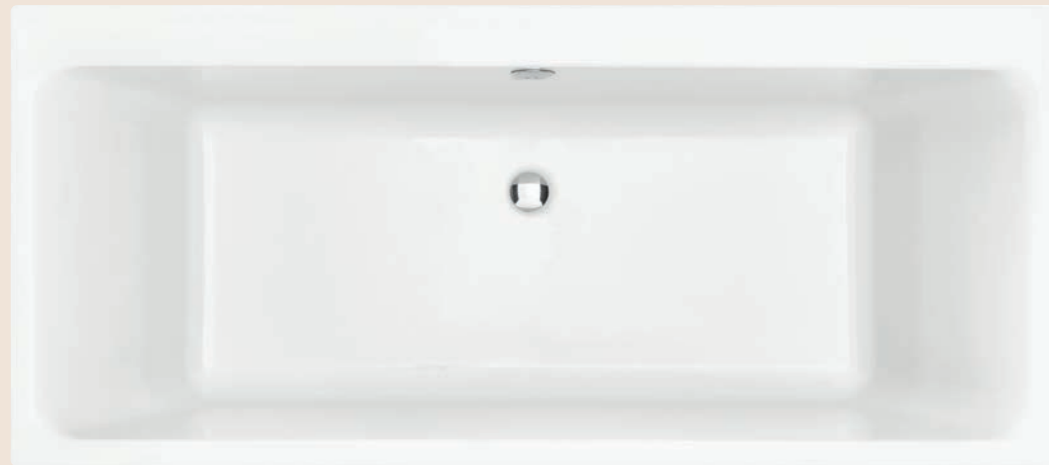

Double Ended Acrylic Bath → Page 124



Dawlish Shower Mixer  
→ Page 130



Hatton Standard Height  
CC Pan → Page 95



Hatton Basin and Pedestal  
→ Page 89

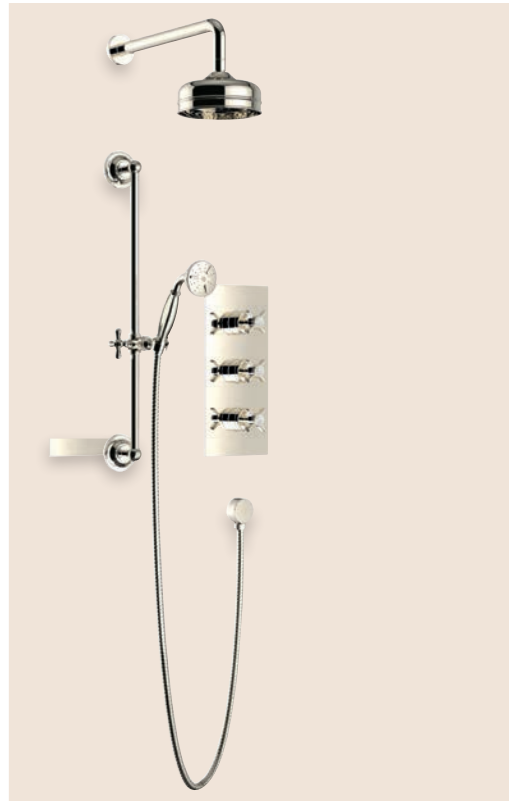

Dawlish Recessed shower with premium  
fixed head and flexible riser kit → Page 131



1. Heritage 'Kingston' illuminated mirror. Find it on page 160. 2. Tinsley rug from Anthropologie. 3. Pair of orange sconce lights from Wayfair.co.uk 4. Soap bar and hand soap from Meraki. 5. 'Merida' towels from Anthropologie. 6. Matisse framed poster from various gallery stores.



Caversham Vanity Unit  
→ Page 64

## THE STORAGE

# Pure vanity

We all need good bathroom storage and the vanity units at Heritage deliver on all counts, providing space to work and display our favourite bathroom things. There are corner units, wall hung units, statement vanities with curved sides and Shaker styles that take colour well. Without good storage, the room wouldn't operate as a practical bathroom. The bonus is when you put things in order, life will feel more organised and in control.

If space is tight, look for a compact vanity unit or furniture that fits into a corner. A curved profile such as our Wilton vanity unit will feel softer and less intrusive than a sharp corner. At Heritage we have a varied range of cabinets and vanity units that you can mix and match to suit your space and how you need it to perform. See page 60 to view the full range.



*Before choosing storage there are things to consider.*

1. How do you use the bathroom, what gadgets do you have and what do you want from your storage space?
2. Next on the list is layout. Once the position of the bath, shower and toilet are worked out, what space is there left for storage?
3. Start early with ideas for flooring. The material choice here will influence the rest of the decoration scheme and furniture finish.
4. Finally, if your house is from a particular period, think about what style suits it best.



## THE DETAILS

# Finishing touches

Never underestimate the power of a good handle. Based on the principle that good design improves our lives, the furniture collections at Heritage feature beautifully crafted details. It is the quality of these finishing touches that elevate the everyday.

Great design is rarely achieved alone. We are proud to collaborate with renowned makers of luxury cabinet handles Crofts & Assinder to provide the finishing touches to our high-level cabinet work. Ever since the company was founded in 1875, the Birmingham-based manufacturer have specialised in fittings that are both beautifully made and stylish.

It is this coming together of style, function and attention to detail that sets the luxury furniture range at Heritage apart.



LOOK N° 5

# Plant power

Invite nature in with this naturally calming bathroom that oozes classic style and material warmth.



**SAGE GREEN**  
This soothing colour works well with cool metallics, such as our Salcombe taps in Chrome.

# N

Natural materials, a green palette and modern design combine to create this tactile bathroom that's in harmony with the outside. From the gleam of the bath to the tread of the timber floor, the decoration of this space is an act of self-care. Everything is good to touch. The clean lines of the Edvin bath and Stamford wall hung pan create the feeling of space.

Salcombe wall mounted basin mixer → Page 142



Stamford rimless wall hung pan → Page 94



Portland floor mounted Towel warmer → Page 176



Salcombe floor standing bath shower mixer → Page 143



*The clean lines of the Edvin bath and Salcombe floor standing bath shower mixer create the feeling of space.*

Edvin bath → Page 110

PLANT POWER

# Create *the look*

Natural colours and materials such as linen, rattan and wood make this feel-good room interesting, adding softness and warmth. The Edvin bath and Stamford sanitaryware are deliberately modern and the Amberley mirror with its hanging strap adds class. Plants add the finishing touch. They are not only lovely to look at but enhance the way you feel. Stress no more.



Edvin bath  
→ Page 110



For our full range of accessories go to  
→ Page 164

Salcombe wall mounted basin mixer  
→ Page 142

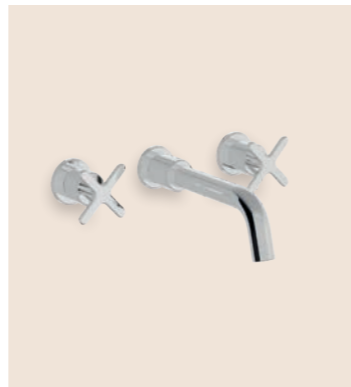

Salcombe floor standing bath shower mixer  
→ Page 143



Stamford wall hung pan  
→ Page 94

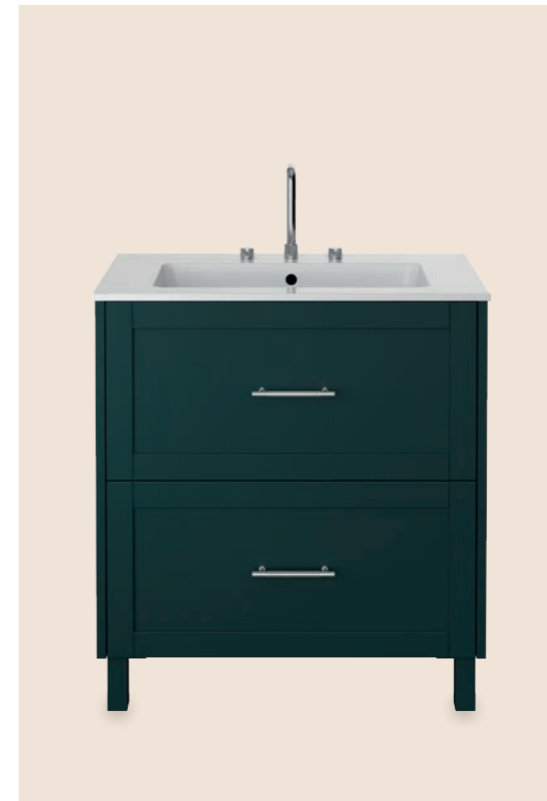

Lynton freestanding vanity unit 800mm  
→ Page 70



Portland floor mounted Towel warmer  
→ Page 176



1. 'Living' hanging ceiling lights from Nordic Nest and Trouva. 2. Heritage 'Amberley' mirror. Find it on page 159. 3. Linen colour waffle towels from Amara. 4. Antique rustic milking stool from Etsy.com 5. Woodwork Beige floor tiles from Porcelain Superstore.





Dawlish  
Recessed Shower  
→ Page 131

#### THE SHOWER

## Wake up and refresh

There are two types of bathroom personalities: shower people or those who prefer to bath. For some, a long shower is the way to clear their heads in the morning, whereas for others, an evening bath is to time to unwind. When planning a new bathroom, it is wise to understand your preference and make that a priority in a scheme – and if space is tight, a shower over the bath combination can be a compromise.

When choosing a new shower, it is important to consider what type of water effect you would like, not only the finished look. An overhead shower gives a greater and more consistent distribution of water, whereas a handheld shower is ideal for a powerful and direct spray – also great for rinsing down your space.



#### THE PLANTS

## Pretty green

When it comes to adding impact, a houseplant is the simplest of decoration fixes. A humid-loving orchid next to a shower or a spider plant on a windowsill will change the atmosphere of a space – as well as lifting spirits.

#### A few tips:

- Tall plants are great for corners and can be a focal point in a room
- Palms will add a tropical vibe. Ferns will also thrive
- Small plants look good in groups of threes with varying heights
- Use glass bowls instead of pots so you can admire the roots too



Salcombe  
concealed shower  
→ Page 144



THE COMPACT SPACE

# Big ideas for tiny rooms

Small is beautiful but when space is tight, every inch counts. Designing any bathroom, particularly rooms on the smaller side, is a bit like doing a jigsaw puzzle. It is important to make all the pieces fit.

At Heritage, we have a really good selection of cabinets and vanity units that will do just this. Keeping a space looking gorgeous and fuss-free, our tall Lynton units won't take up any vital floor space, allowing products to be hidden away. ▶



Lynton freestanding cloakroom unit  
→ Page 69



Granley WC and basin and pedestal  
→ Page 93



Caversham freestanding cloakroom unit  
→ Page 69



Dorchester wall hung toilet with basin and pedestal  
→ Page 92

THE CLOAKROOM

## Colour schemes that work

Our Caversham freestanding cloakroom unit will neatly tuck into the tiniest of spots. Combine with our Newick circular mirror to add depth and create the illusion of more space. Surrounded by LED's, it will bounce light around the room.

With practicalities taken care of, there is scope to have fun with the decoration. As the space is small, material costs are fewer – making it easier to commit to a look that is more daring than you might do in the main family bathroom. Go to town with a particular colour or theme, with the reassurance that decoration surprises will always make you smile.

**STYLISH STORAGE**

Our Lynton and Caversham vanities lead the decor direction. The simple style works beautifully with muted colour combinations – and works in any size space. Remember: you can only keep a room tidy, if there's a place for everything to go!

A cloakroom doesn't have to be a neglected, cluttered space but can be a stylish room full of character. Yellow walls and gold accessories will make a space feel sunnier. Cream painted units and natural wood keeps any dazzle at bay. For a serene feel, dark blue cabinets and walls feel cosy. Red fabric wall lights contrast beautifully as well as adding a decorative touch. A two-tone option is a way to introduce colour without it taking over the entire room. For example, paint vanity doors and the lower half of the walls in a strong colour, paired with muted shades above.

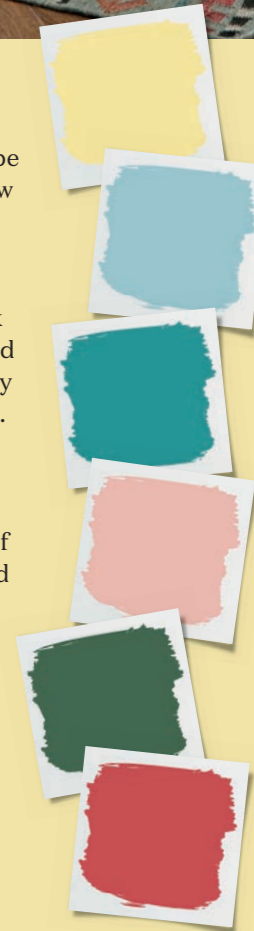

# Get the *know-how*

## Expert advice and planning tips

A bathroom renovation doesn't need to be a daunting prospect if you follow a few basic steps. Beyond knowing your budget and the style of bathroom you would like, there is an order of works. Over the next few pages, we take you through the key points to consider, from water pressure and plumbing questions, choosing the right fittings, and making the most of available space.



# Planning *the space*

Most of our showroom partners offer a design service that will bring your bathroom ideas to life. From help with design options, to installation and maintenance advice, our specialist retailers are the experts when it comes to bathroom design. But here are some things you might want to consider before planning your visit.

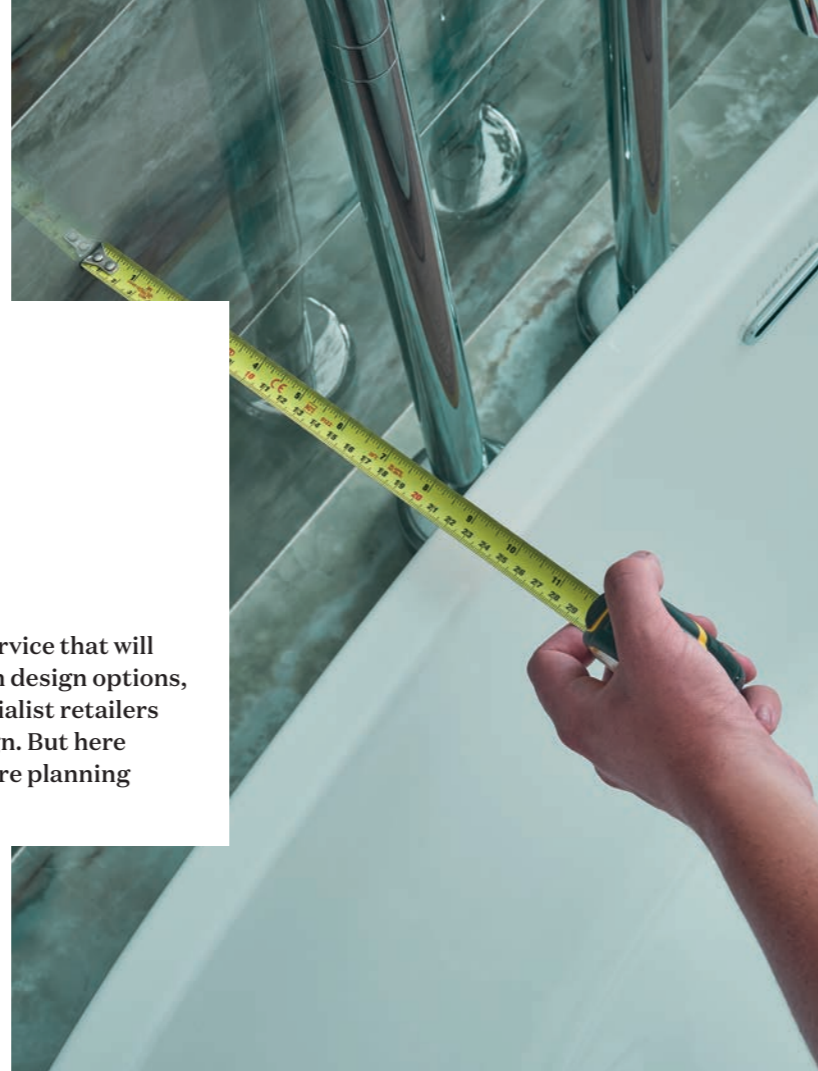

**1. Think about the function** of your bathroom before you decide on style, bearing in mind where existing plumbing is for essentials such as the toilet, basin, shower or bath. This will all help with the room plan and what fits in the space.

**2. Identify storage needs** and consider the type of furniture you want to incorporate. Add this to your floor plan, trying different options before committing to a final design. Our showroom partners have design tools to help or use our online 3D bathroom planner to map out your space.

**3. Consider water pressure and flow.** This is fundamental before choosing a shower system. Our retail partners or Customer Service team can advise on what products will work best for your boiler type. Also, think about what plumbing is required for underfloor heating or radiators at this point too. If you would like a wall-hung toilet a special frame and plumbing will need to be fitted behind a stud/false wall.

**4. Lighting requirements** need to be thought about at an early stage. What type of lighting would you like? Wall lights for tasks, low level lighting for mood? What wiring is required? This will need to be built into the walls. Also, consider electrics for shaver sockets and towel rails now.

**5. Choose materials carefully.** Durability, aesthetics, and cost are all factors. Choose non-porous tiles that can cope with wet conditions and think about what colour grouting you would like. Darker colours will show less dirt. When painting walls, choose a water-resistant eggshell finish or bathroom paint that is suited to wet room environments.

**6. What style do you want?** This will inform the products you choose and the finishes. It's a good idea to think ahead. Will it stand the test of time?



# Room to *improve*

Whether you're upgrading an existing bathroom or putting in an ensuite, our expert tips will help make the most of any size space.

- ~ Installing a new suite is a chance to evaluate where everything is positioned. If pipework isn't in the right place, it can be moved. This can add time and cost to a project, but it can be practical if the original layout of the bathroom fundamentally doesn't work.
- ~ In large bathrooms, think about freestanding furniture. Chairs are a great way to soften hard surfaces of bathroom fittings and add comfort.
- ~ Ensuites are an extension of the bedroom. The door will often be open and viewable from the bed, so choose materials and a colour scheme that will match so both spaces coordinate well. A box room makes a great ensuite, which can be achieved with a connecting door.
- ~ For small spaces, wall-hung units are ideal as they save precious floor space. A freestanding vanity unit is a good choice for families as they offer masses of storage as well as countertop space.
- ~ For cloakrooms, choose only essentials. Make a sink a feature with a beautiful mirror above it and excellent storage below. It may seem counter-intuitive, but a large vanity unit will make a room feel bigger, and more usable. See page 60 for ideas.
- ~ If planning to extend upwards into an attic space, consider the layout of the bathroom and the positions above a drainage floor below.

### FIND A SHOWROOM

Located across the UK, our specialist Heritage retailers provide expert guidance and help to bring bathroom ideas to life. Visit [heritagebathrooms.com](https://www.heritagebathrooms.com) to find the Heritage retailer closest to you.



# Draw it up

Using a sheet of A4 graph paper make a sketch of your bathroom's floor layout. Mark out any doors, windows, radiators, and existing plumbing. Don't forget to mark which way the door opens. By having a layout, it makes it easier for big plumbing decisions to be made, for instance, the toilet needs to be placed within easy access of the waste pipe and will dictate how everything else is arranged.

Pick a starting point and work clockwise, measuring the height of the room too, plus any other vertical distances so the whole room is mapped. Online planners will help give shape to ideas, which you can take to the planning stage, or draw by hand. Turn to page 184 for blank graph paper to get started.

# Product focus

There are many things to think about when selecting a product. Will it fit? What features do I need? Does it work with existing plumbing? Is it within budget? At Heritage, our products are designed to cover all scenarios and can be co-ordinated across ranges to get the look and price point desired. We break down what you need to know.



## Taps

Your choice of basin will dictate your options for taps, with one, two or three tap hole versions available. Alternatively, opt for wall-mounted hardware instead. If you prefer taps to be wall-mounted, decide this early on as the correct plumbing will need to be installed before tiling or fitting can commence. Heritage baths are available with either two tap holes, or none. Here, you would use a bath shower mixer that sits beside your bath to fill it.



## Basins

The choice with basins is between size and style. At Heritage, our basins range from compact or corner-shaped sinks that are good for small spaces to larger basins such as Dorchester that sit on top of a chrome frame. This creates the illusion of space. Our bestselling Granley range is a timeless design. For large spaces or family bathrooms, consider fitting two basins side by side, hotel style. This means there is plenty of space for everyone. Classic taps combined with contemporary sanitaryware gives an interesting effect.



## Baths

With a bath you have to ask yourself what's important and what's realistic? Only by measuring a space can you get an accurate idea of what will work in a space, and where. Scaled down versions will work where space is tight. Material choice too plays a part too. Cast iron baths are luxurious and incredibly durable, whereas acrylic baths are highly polished, scratch and stain resistant and lighter than cast iron.



## Showers

The performance of your shower will depend on your water system, so it's always best to check with your plumber or your showroom before selecting a shower. For the most flexibility, choose an overhead design with handheld shower. The handheld function is great for rinsing down the enclosure, too.



## Furniture

At Heritage, our furniture makes the most of any available space – as well as keeping it tidy. Made to a high quality, our free-standing and wall-hung vanity and storage units are available in a range of colours and handle options.

# Need to Know... Tile Style

Tiling a bathroom is a skilled job, requiring specific cutting tools and experience. Most tilers will start with the walls before moving on to the floor, beginning in the middle of the wall, working outwards. If you are project managing yourself, you'll need to be aware that the tiler can only start working once the 'first fix' has been done on the plumbing, the electrics have been installed and any plastering has been completed.

The fun part of tiling is choosing the material as tiles provide an opportunity to add colour, texture, and pattern into a space. The size of tile, the material, and how the tiles are laid all effect the finished bathroom look. Here are a few pointers to achieve various effects.

- ~ Mosaics can be stunning in both a classic and modern space. They add texture and offer a variety of ombre effects. Start with a darker tile at the bottom, working lighter at the top.
- ~ Large tiles on a large wall add to the feeling of space. Use these in a compact room and it will feel more luxurious.
- ~ If you continue using tiles that are used on the walls onto the floor as well, it will make a room feel seamless. By using an intense single colour, the look is dramatic.
- ~ Behind a washbasin, tile to head height rather than just a splashback. Metro tiles stacked vertically will give a modern feel.
- ~ A glazed handmade tile reflects light beautifully and will add a rustic touch.
- ~ Green is a popular colour in the bathroom. It adds an earthy colour whilst still feeling calm.
- ~ Classic square tiles installed in a grid pattern give a retro feel – the effect boosted by using a contrast-coloured grout.
- ~ Colour blocking is a simple way to be bold. Use one primary colour such as yellow with a complementary orange in different areas of the room.

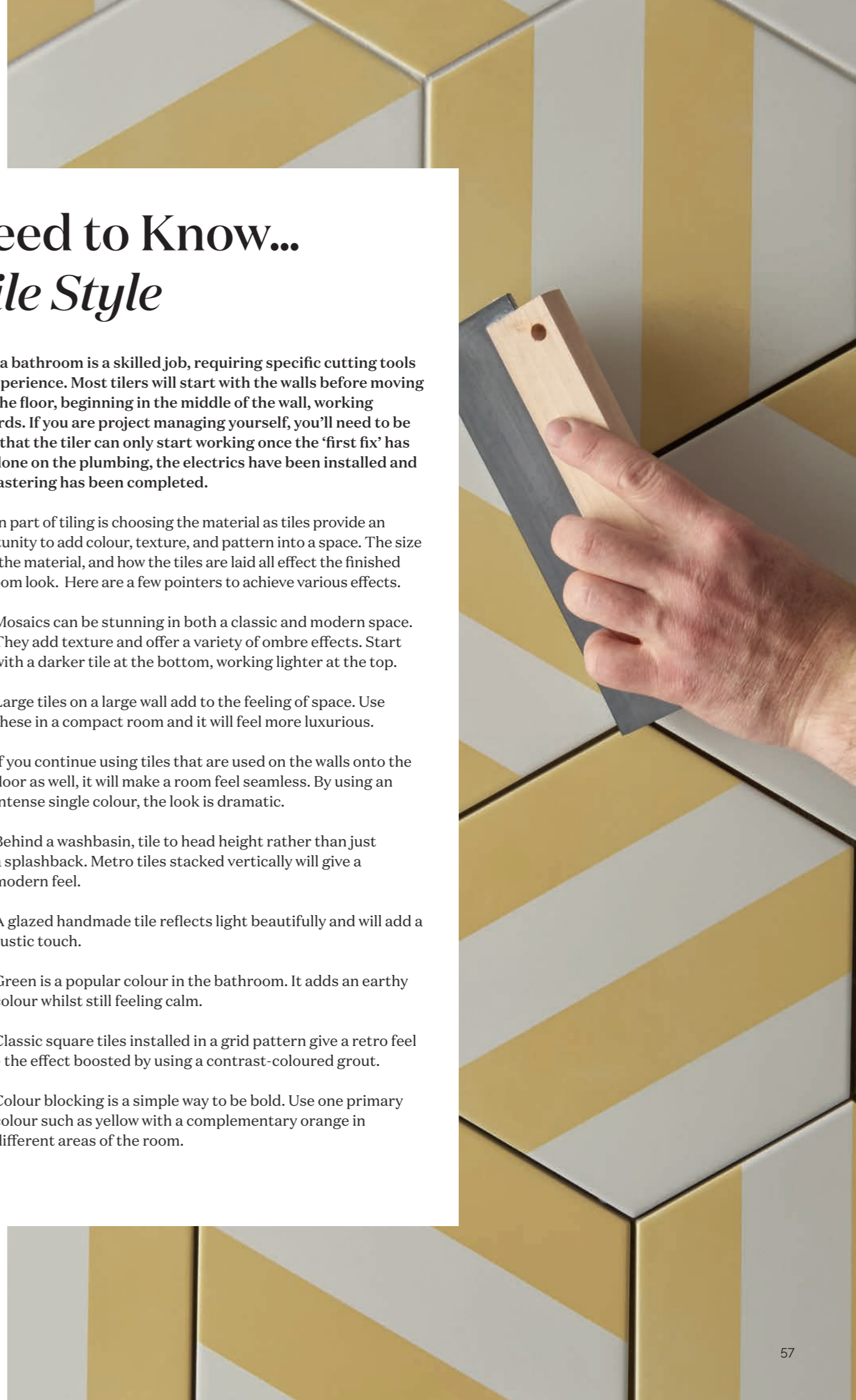

# Product *selection*

Our definitive guide to choosing the right fittings and accessories to suit your space.



# Furniture



Heritage bathroom furniture is designed with style and practicality in mind.

From the classic Caversham, to the timeless design of Wilton, or the elegantly modern Lynton, all of our ranges give you beautiful bathroom storage you can enjoy for years to come with a robust five year guarantee.

Available in a range of on trend finishes, you can also choose from a range of durable worktops and stylish handles to create a truly unique look.



# Furniture Options

Add character to your bathroom with our range of bathroom furniture. From freestanding units to wall hung options, we have a wide range of widths to choose from to create your perfect space. We also have cloakroom options for those smaller spaces



Cloakroom Unit



600mm Unit



700mm Wall Hung Unit



800mm Unit



1000mm Corner Unit



1200mm Unit

## Furniture - Additional Product Options

Range	WC unit	Tall Wall Cabinet	Freestanding Tall Boy	Single Mirror Cabinet	Double Mirror Cabinet	Framed Mirror
Caversham	✓		✓	✓	✓	✓
Lynton	✓	✓	✓			
Wilton						
Broughton						

# Furniture Finishes

Within our ranges, you can select different colour finish options. For a timeless look opt for our neutral Dove Grey or Chantilly, or for a bolder touch try Midnight Blue or Classic Green. Check the matrix below to see what colours we offer in each range.

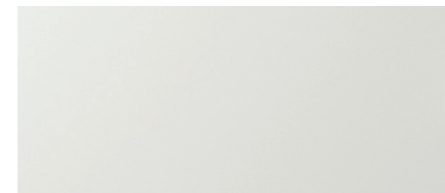

Chantilly



Dove Grey

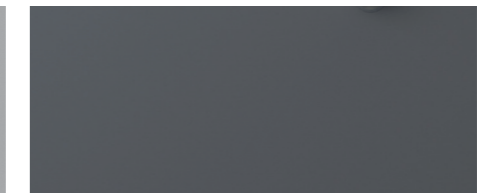

Graphite



Maritime Blue



Midnight Blue



Classic Green

## Finishes - Options

Range	Chantilly	Dove grey	Graphite	Maritime blue	Midnight blue	Classic green
Broughton	✓		✓	✓		
Caversham	✓		✓	✓		
Lynton		✓			✓	✓
Wilton	✓		✓	✓		

Complete the look with a matching toilet seat (page 79) or bath panel (page 78) and choose from our beautiful selection of handles (pages 76 - 77).

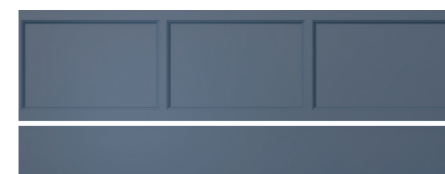

Bath Panel Maritime Blue



WC Seat Maritime Blue



Chrome Door Knob



# Broughton

## Washstand 800mm

Chantilly	BRCH8001D	£1199
Maritime Blue	BRMB8001D	£1199
Graphite	BRGR8001D	£1199

### Vessel Basins

Chiswick	Round	PCHW14	£294
Redford	Round	PRFW10	£250
Berkhamsted	Oblong	PBHW10	£300
Keymer	Oblong	PKMW10	£345

*Basins to be used with a worktop - sold separately.*

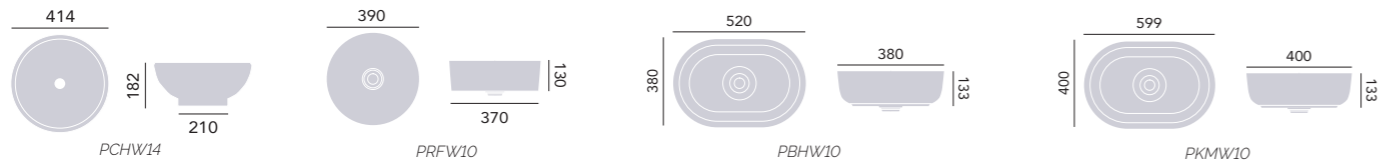
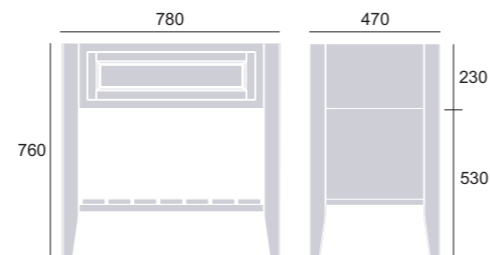

# Broughton

## Double Washstand 1200mm

Chantilly	BRCH12002D	£1499
Maritime Blue	BRMB12002D	£1599
Graphite	BRGR12002D	£1599

### Vessel Basins

Chiswick	Round	PCHW14	£294
Redford	Round	PRFW10	£250
Berkhamsted	Oblong	PBHW10	£300
Keymer	Oblong	PKMW10	£345

*Basins to be used with a worktop - sold separately.*

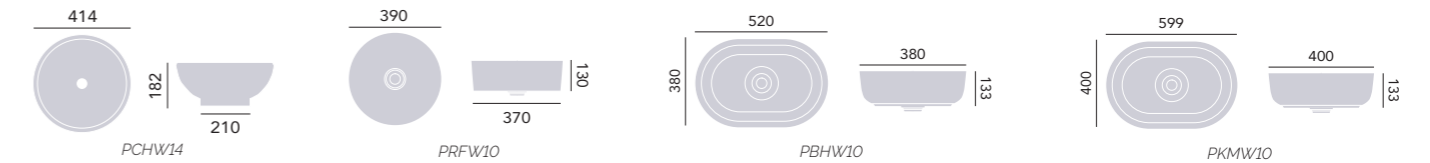
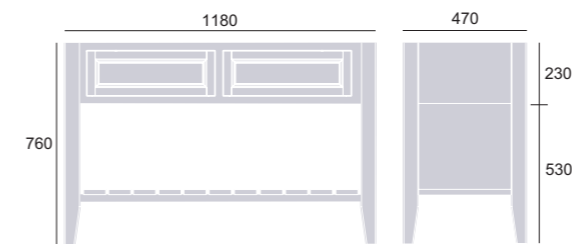

## Single Washstand 1200m

Chantilly	BRCH12001D	£1499
Maritime Blue	BRMB12001D	£1499
Graphite	BRGR12001D	£1499

### Vessel Basins

Chiswick	Round	PCHW14	£294
Redford	Round	PRFW10	£250
Berkhamsted	Oblong	PBHW10	£300
Keymer	Oblong	PKMW10	£345

*Basins to be used with a worktop - sold separately.*

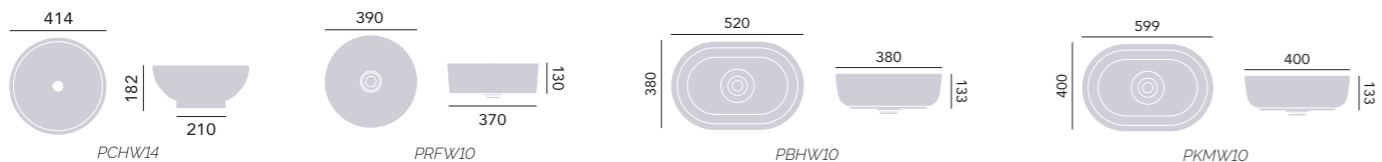
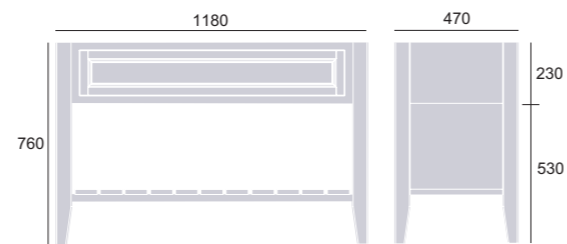

## Caversham Wall Hung Furniture



### Wall Hung One Drawer Vanity 700mm

Chantilly		KCHWH	£545
Maritime Blue		KMBWH	£545
Graphite		KGRWH	£545

### Vessel Basins

Chiswick	Round	PCHW14	£294
Redford	Round	PRFW10	£250
Berkhamsted	Oblong	PBHW10	£300
Keymer	Oblong	PKMW10	£345

### Kirkham Basins

1 Taphole Basin	1 Taphole Basin	PKIW051	£300
2 Taphole Basin	2 Taphole Basin	PKIW05	£306

Basins to be used with a worktop - sold separately.

Handle positions are not pre-drilled - select a stylish handle from our on-trend range. Use with a worktop - sold separately.

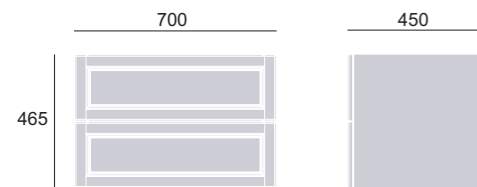
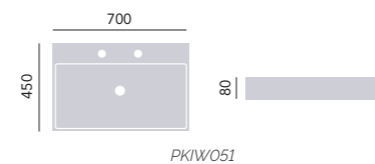

### Wall Hung Two Drawer Vanity 700mm

Chantilly		KCH70WH	£625
Maritime Blue		KMB70WH	£625
Graphite		KGR70WH	£625

### Vessel Basins

Chiswick	Round	PCHW14	£294
Redford	Round	PRFW10	£250
Berkhamsted	Oblong	PBHW10	£300
Keymer	Oblong	PKMW10	£345

### Kirkham Basins

1 Taphole Basin	1 Taphole Basin	PKIW051	£300
2 Taphole Basin	2 Taphole Basin	PKIW05	£306

Basins to be used with a worktop - sold separately.

Handle positions are not pre-drilled - select a stylish handle from our on-trend range. Use with a worktop - sold separately.

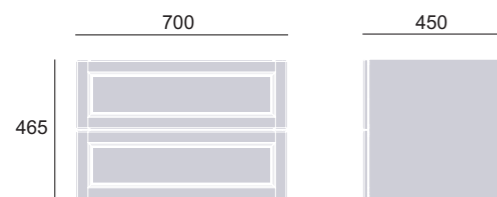
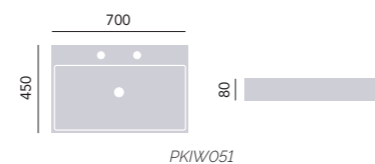

Chantilly



Maritime Blue



Graphite

## Caversham Wall Hung Furniture

### Wall Hung One Drawer Vanity 700mm

Chantilly		KCHWH (x2)	£545
Maritime Blue		KMBWH (x2)	£545
Graphite		KGRWH (x2)	£545

### Vessel Basins

Chiswick	Round	PCHW14 (x2)	£294
Redford	Round	PRFW10 (x2)	£250
Berkhamsted	Oblong	PBHW10 (x2)	£300
Keymer	Oblong	PKMW10 (x2)	£345

Basins to be used with a worktop - sold separately.

Handle positions are not pre-drilled - select a stylish handle from our on-trend range. Use with a worktop - sold separately.

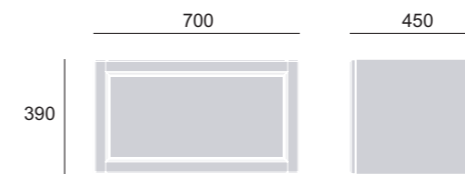

Use with a 1400mm worktop

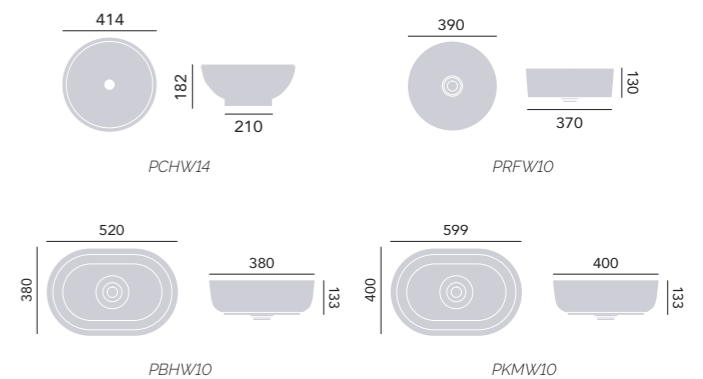

### Wall Hung Two Drawer Vanity 700mm

Chantilly		KCH70WH (x2)	£625
Maritime Blue		KMB70WH (x2)	£625
Graphite		KGR70WH (x2)	£625

### Vessel Basins

Chiswick	Round	PCHW14 (x2)	£294
Redford	Round	PRFW10 (x2)	£250
Berkhamsted	Oblong	PBHW10 (x2)	£300
Keymer	Oblong	PKMW10 (x2)	£345

Basins to be used with a worktop - sold separately.

Handle positions are not pre-drilled - select a stylish handle from our on-trend range. Use with a worktop - sold separately.

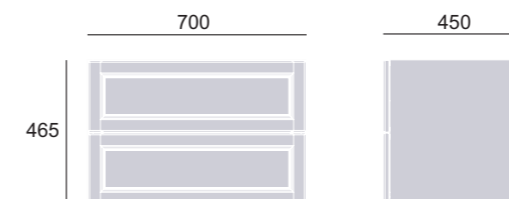

Use with a 1400mm worktop

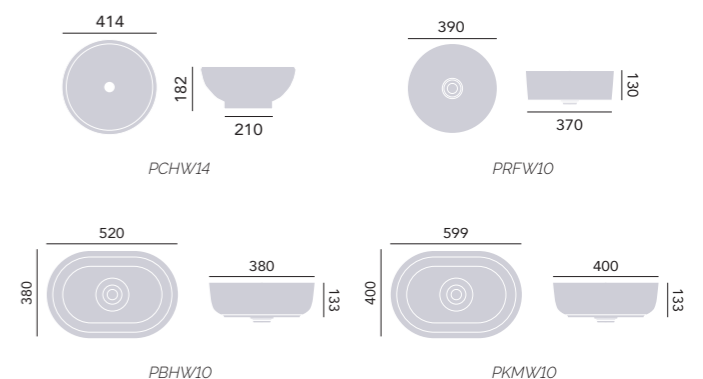

## Caversham Freestanding Furniture



### Caversham Freestanding Dorchester Vanity

Chantilly	KCHDR34	£699
Maritime Blue	KMBDR34	£699
Graphite	KGRDR34	£699

### Under Counter Basin

PVERW15	£205
---------	------

Handle positions are not pre-drilled. Select stylish handles from our on-trend range. Removable shelf included. Use with a worktop - sold separately.

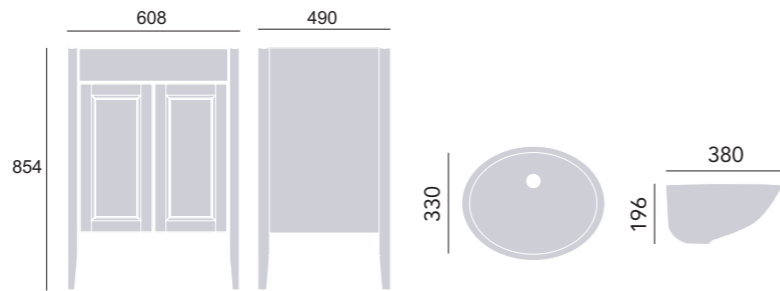

### Caversham Freestanding Granley Vanity

Chantilly	KCHGR34	£699
Maritime Blue	KMBGR34	£699
Graphite	KGRGR234	£699

### Under Counter Basin

PVERW15	£205
---------	------

Handle positions are not pre-drilled. Select stylish handles from our on-trend range. Removable shelf included. Use with a worktop - sold separately.

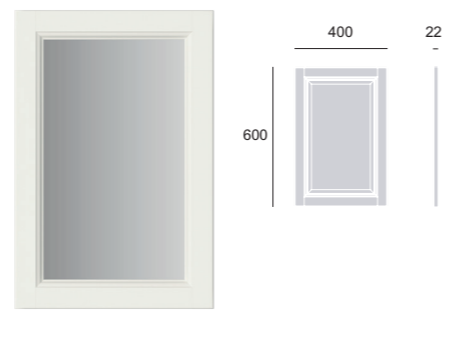
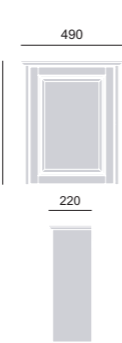
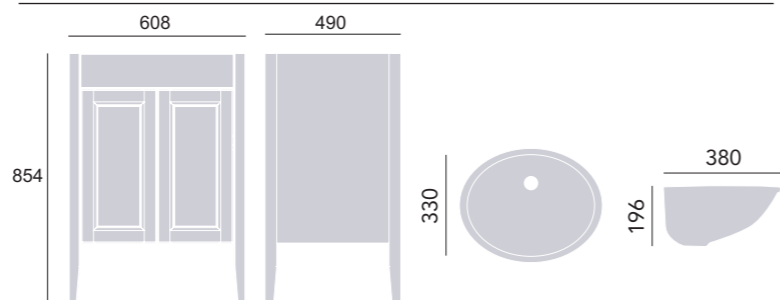

### Double Door Mirror Wall Cabinet

Chantilly	KCHDMWU	£465
Maritime Blue	KMBDMWU	£465
Graphite	KGRDMWU	£465

### Single Door Mirror Wall Cabinet

Chantilly	KCHSMWU	£375
Maritime Blue	KMBSMWU	£375
Graphite	KGRSMWU	£375

### Framed Mirror 400mm

Chantilly	KCHF400	£145
Maritime Blue	KMBF400	£145
Graphite	KGRF400	£145

## Caversham Freestanding Furniture



### Freestanding Cloakroom Unit 400mm

Chantilly	KCH4034	£399
Maritime Blue	KMB4034	£399
Graphite	KGR4034	£399

### Caversham/Lynton Cloakroom Basin

1 Tap Hole	PLYW071	£149
------------	---------	------

Handle positions are not pre-drilled. Select stylish handles from our on-trend range, see p74 and 75.

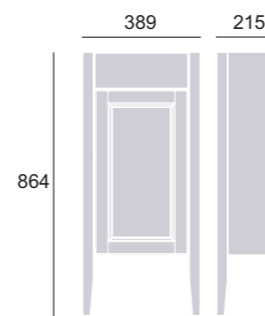

### Wall Hung Cloakroom Unit 400mm

Chantilly	KCH40WH	£345
Maritime Blue	KMB40WH	£345
Graphite	KGR40WH	£345

### Caversham/Lynton Cloakroom Basin

1 Tap Hole	PLYW071	£149
------------	---------	------

Handle positions are not pre-drilled. Select stylish handles from our on-trend range, see p74 and 75.



### WC Unit 600mm

Chantilly	KCHWCU600	£425
Maritime Blue	KMBWCU600	£425
Graphite	KGRWCU600	£425

For use with a back to wall WC. Use with a worktop - sold separately.

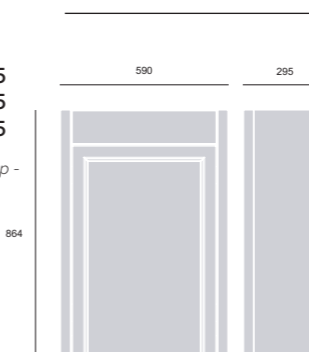

### Freestanding Tall Boy

Chantilly	KCHTB	£950
Maritime Blue	KMBTB	£950
Graphite	KGRTB	£950

Handle positions are not pre-drilled. Select stylish handles from our on-trend range, see p74 and 75.

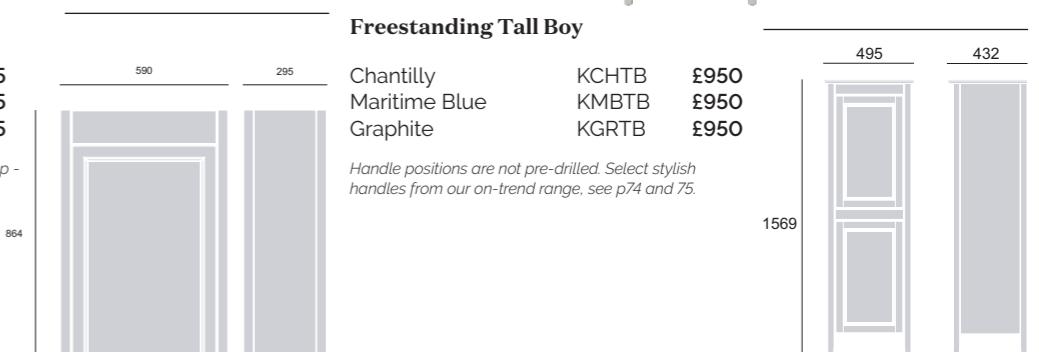

# Lynton

## Lynton 600mm Freestanding Vanity

Dove Grey	LYDG6034	£849
Classic Green	LYCG6034	£849
Midnight Blue	LYMB6034	£849

## Lynton 600mm Sit on Basin

0 Tap Hole	PLYW061	£225
1 Tap Hole	PLYW051	£250
2 Tap Hole	PLYW05	£285
3 Tap Hole	PLYW053	£285

## Vessel Basins to use with Worktop

Chiswick	Round	PCHW14	£294
Redford	Round	PRFW10	£250
Berkhamsted	Oblong	PBHW10	£300
Keymer	Oblong	PKMW10	£345

Basins to be used with a worktop - sold separately. Handle positions are not pre-drilled. Select stylish handles from our on-trend range. Basins are supplied with a white/chrome overflow, if you require black or brushed brass order from p156.

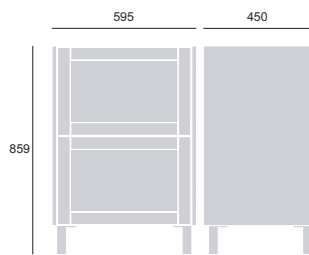

## Lynton 800mm Freestanding Vanity

Dove Grey	LYDG8034	£949
Classic Green	LYCG8034	£949
Midnight Blue	LYMB8034	£949

## Lynton 800mm Sit on Basin

0 Tap Hole	PLYW061	£275
1 Tap Hole	PLYW051	£299
2 Tap Hole	PLYW05	£335
3 Tap Hole	PLYW053	£335

## Vessel Basins to use with Worktop

Chiswick	Round	PCHW14	£294
Redford	Round	PRFW10	£250
Berkhamsted	Oblong	PBHW10	£300
Keymer	Oblong	PKMW10	£345

Basins to be used with a worktop - sold separately. Handle positions are not pre-drilled. Select stylish handles from our on-trend range. Basins are supplied with a white/chrome overflow, if you require black or brushed brass order from p156.



## Lynton 600mm Wall Hung Vanity

Dove Grey	LYDG60WH	£849
Classic Green	LYCG60WH	£849
Midnight Blue	LYMB60WH	£849

## Lynton 600mm Sit on Basin

0 Tap Hole	PLYW061	£225
1 Tap Hole	PLYW051	£250
2 Tap Hole	PLYW05	£285
3 Tap Hole	PLYW053	£285

## Vessel Basins to use with Worktop

Chiswick	Round	PCHW14	£294
Redford	Round	PRFW10	£250
Berkhamsted	Oblong	PBHW10	£300
Keymer	Oblong	PKMW10	£345

Basins to be used with a worktop - sold separately. Handle positions are not pre-drilled. Select stylish handles from our on-trend range. Basins are supplied with a white/chrome overflow, if you require black or brushed brass order from p156.

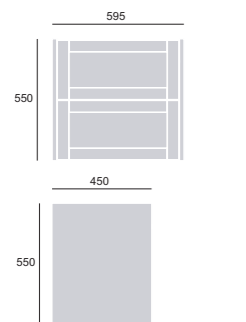

## Lynton 800mm Wall Hung Vanity

Dove Grey	LYDG80WH	£949
Classic Green	LYCG80WH	£949
Midnight Blue	LYMB80WH	£949

## Lynton 800mm Sit on Basin

0 Tap Hole	PLYW061	£275
1 Tap Hole	PLYW051	£299
2 Tap Hole	PLYW05	£335
3 Tap Hole	PLYW053	£335

## Vessel Basins to use with Worktop

Chiswick	Round	PCHW14	£294
Redford	Round	PRFW10	£250
Berkhamsted	Oblong	PBHW10	£300
Keymer	Oblong	PKMW10	£345

Basins to be used with a worktop - sold separately. Handle positions are not pre-drilled. Select stylish handles from our on-trend range. Basins are supplied with a white/chrome overflow, if you require black or brushed brass order from p156.

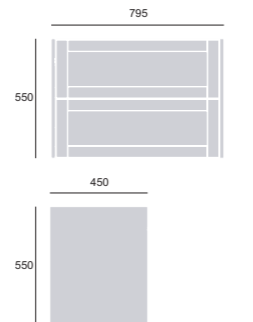

# Lynton



## Lynton Floorstanding Cloakroom Unit

Dove Grey	LYDG4034	£349
Classic Green	LYCG4034	£349
Midnight Blue	LYMB4034	£349

## Caversham/Lynton Cloakroom Basin

1 Tap Hole	PLYW071	£149
------------	---------	------

Handle positions are not pre-drilled. Select stylish handles from our on-trend range. Basins are supplied with a white/chrome overflow, if you require black or brushed brass order from p156.

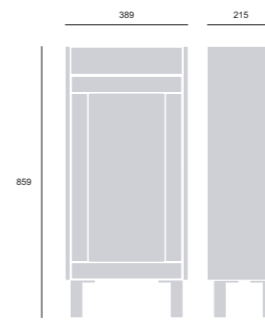

## Lynton Wall Hung Cloakroom Unit

Dove Grey	LYDG40WH	£349
Classic Green	LYCG40WH	£349
Midnight Blue	LYMB40WH	£349

## Caversham/Lynton Cloakroom Basin

1 Tap Hole	PLYW071	£149
------------	---------	------

Handle positions are not pre-drilled. Select stylish handles from our on-trend range. Basins are supplied with a white/chrome overflow, if you require black or brushed brass order from p156.

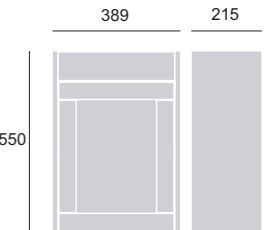

## Lynton Freestanding Tall Cabinet - 350mm

Dove Grey	LYDGTB	£499
Classic Green	LYCGTB	£499
Midnight Blue	LYMBTB	£499

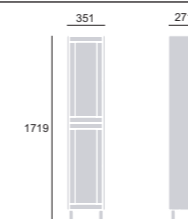

Handle positions are not pre-drilled. Select stylish handles from our on-trend range.



## Lynton Tall Wall Cabinet - 350mm

Dove Grey	LYDGTWC	£549
Classic Green	LYCGTWC	£549
Midnight Blue	LYMBTWC	£549

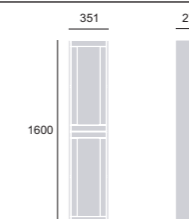

Handle positions are not pre-drilled. Select stylish handles from our on-trend range.



## Lynton WC Unit - 550mm

Dove Grey	LYDGWCU550	£349
Classic Green	LYCGWCU550	£349
Midnight Blue	LYMBWCU550	£349

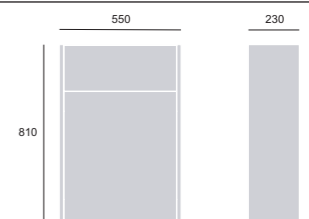

Use with a back to wall pan and concealed cistern. Use with a worktop - sold separately.

# Wilton



### Wilton 1200mm Curved Vanity

Chantilly	WICHCU	£1849
Maritime Blue	WIMBCU	£1849
Graphite	WIGRCU	£1849

<b>Under Counter Basin</b>	PVERW15	£205
----------------------------	---------	------

*Use with undermount basins and a worktop (sold separately). Handle positions are not pre-drilled. Select stylish handles from our on-trend range.*

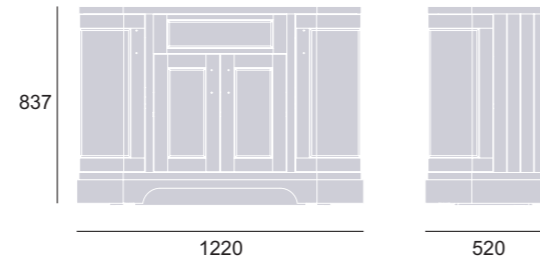

# Wilton

### Wilton 600mm Freestanding Vanity

Chantilly	WICH6034	£799
Maritime Blue	WIMB6034	£799
Graphite	WIGR6034	£799

<b>Under Counter Basin</b>	PVERW15	£205
----------------------------	---------	------

*Use with undermount basins and a worktop (sold separately). Handle positions are not pre-drilled. Select stylish handles from our on-trend range.*

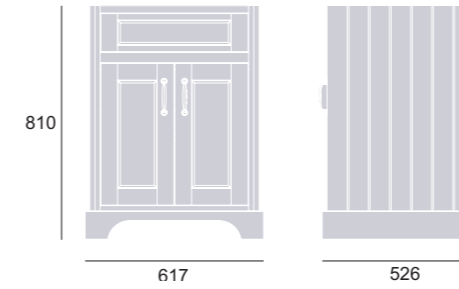

### Wilton 1000mm Corner Left Hand Vanity

Chantilly	WICHLHCU	£1399
Maritime Blue	WIMBLHCU	£1399
Graphite	WIGRLHCU	£1399

<b>Under Counter Basin</b>	PVERW15	£205
----------------------------	---------	------

*Use with undermount basins and a worktop (sold separately). Handle positions are not pre-drilled. Select stylish handles from our on-trend range.*

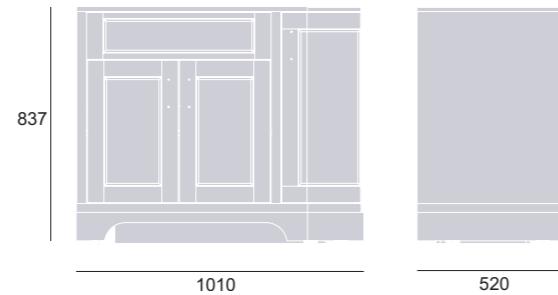

### Wilton 800mm Freestanding Vanity

Chantilly	WICH8034	£899
Maritime Blue	WIMB8034	£899
Graphite	WIGR8034	£899

<b>Under Counter Basin</b>	PVERW15	£205
----------------------------	---------	------

*Use with undermount basins and a worktop (sold separately). Handle positions are not pre-drilled. Select stylish handles from our on-trend range.*

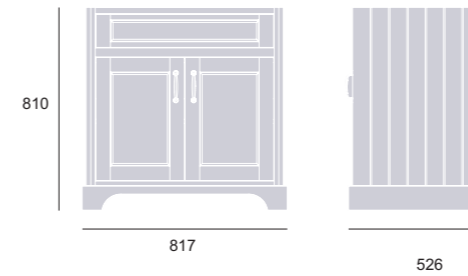

### Wilton 1000mm Corner Right Hand Vanity

Chantilly	WICHRHCU	£1399
Maritime Blue	WIMBRHCU	£1399
Graphite	WIGRRHCU	£1399

<b>Under Counter Basin</b>	PVERW15	£205
----------------------------	---------	------

*Use with undermount basins and a worktop (sold separately). Handle positions are not pre-drilled. Select stylish handles from our on-trend range.*

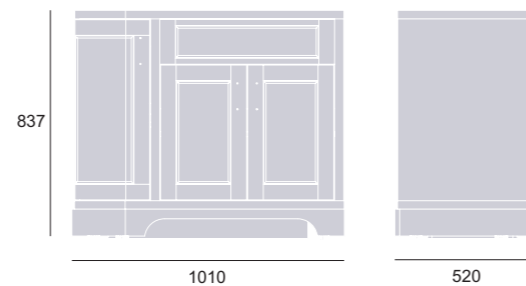

## Broughton, Caversham, Dorchester & Granley Worktops



White Marble



Dark Concrete

### Broughton Worktop 800mm

White Marble	WTBRWHCL800	£379
Dark Concrete	WTBRDCCL800	£329

### Broughton Worktop 1200mm

White Marble	WTBRWHCL1200	£599
Dark Concrete	WTBRDCCL1200	£549



White Marble



Dark Concrete

### Caversham Wall Hung Vanity Unit Worktop 700mm

White Marble	WTKWHCL700	£159
Dark Concrete	WTKDCCL700	£149
Oak	WTKOAK700	£149

### Caversham Wall Hung Vanity Unit Worktop 1400mm

White Marble	WTKWHCL1400	£245
Dark Concrete	WTKDCCL1400	£225
Oak	WTKOAK1400	£225

### WC Unit Worktop 600mm

White Marble	WTKWHCL600	£139
Dark Concrete	WTKDCCL600	£139
Oak	WTKOAK600	£139



Oak



White Marble



Dark Concrete

### Dorchester Freestanding Vanity Worktops 600mm

White Marble	WTKDORWHCL600	£285
Dark Concrete	WTKDORDCCL600	£235

*For use with undercounter basins*

### Granley Freestanding Vanity Worktops 600mm

White Marble	WTKGRAWHCL600	£285
Dark Concrete	WTKGRADCCL600	£235

## Lynton & Wilton Worktops

### Lynton Worktop For WC Unit

White Marble	WTLYWHCL550	£125
Dark Concrete	WTLYDCCL550	£125

### Lynton 600mm Worktop

White Marble	WTLYWHCL600	£299
Dark Concrete	WTLYDCCL600	£249

### Lynton 800mm Worktop

White Marble	WTLYWHCL800	£349
Dark Concrete	WTLYDCCL800	£299



White Marble



Dark Concrete

### Wilton 600mm Worktop

White Marble	WTWIWHCL600	£349
Dark Concrete	WTWIDCCL600	£299

### Wilton 800mm Worktop

White Marble	WTWIWHCL800	£379
Dark Concrete	WTWIDCCL800	£329

### Wilton 1000mm Corner Worktop - Left Hand

White Marble	WTWIWHLHCL1000	£419
Dark Concrete	WTWIDCLHCL1000	£349

### Wilton 1000mm Corner Worktop - Right Hand

White Marble	WTWIWHRHCL1000	£419
Dark Concrete	WTWIDCRHCL1000	£349

### Wilton 1200mm Curved Worktop

White Marble	WTWIWHCL1200	£599
Dark Concrete	WTWIDCCL1200	£549



White Marble



Dark Concrete

# Handles



### Round Knob

H 28mm x W 28mm x D 50mm

AHC20 Chrome Plated  
AHA20 Vintage Gold

£8  
£8

### Ceramic Door Knob Cream

H 45mm x W 45mm x D 45mm

FKNCE01

### Crystal & Chrome Door Knob

H 24mm x W 24mm x D 35mm

FKNCC01

£18

# Handles



### Round Knob 29mm

H 29mm x W 29mm x D 29mm

AHC110 Chrome Plated  
AHBL110 Black  
AHBB110 Brushed Brass  
AHBN110 Brushed Nickel

£22  
£25  
£25  
£27

### Round Knob 38mm

H 38mm x W 38mm x D 32mm

AHC106 Chrome Plated  
AHBL106 Black  
AHBB106 Brushed Brass  
AHBN106 Brushed Nickel

£11  
£11.5  
£12  
£12

### Bar Handle 192mm

H 10mm x W 230mm x D 35mm

AHC109 Chrome Plated  
AHBL109 Black  
AHBB109 Brushed Brass

£59  
£59  
£59

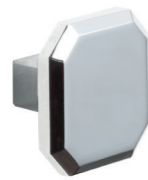

### Chrome Door Handle with Circular Base

H 15mm x W 142mm x D 35mm

FPHCH02

£14

### Beveled Chrome Door Knob

H 34mm x W 34mm x D 23mm

FKNSC01

### Cup Handle 64mm

H 48mm x W 104mm x D 30mm

AHC105 Chrome Plated  
AHBL105 Black  
AHBB105 Brushed Brass  
AHBN105 Brushed Nickel

£12  
£14  
£14  
£13



### Pull Handle 128mm

H 10mm x W 165mm x D 34mm

AHC108 Chrome Plated  
AHBL108 Black  
AHBB108 Brushed Brass

£50  
£57  
£57

### Pull Handle 160mm

H 20mm x W 232mm x D 26mm

AHC107 Chrome Plated  
AHBL107 Black  
AHBB107 Brushed Brass  
AHBN107 Brushed Nickel

£15  
£16  
£17  
£17

All handles sold individually

## Bath Panels



Chantilly

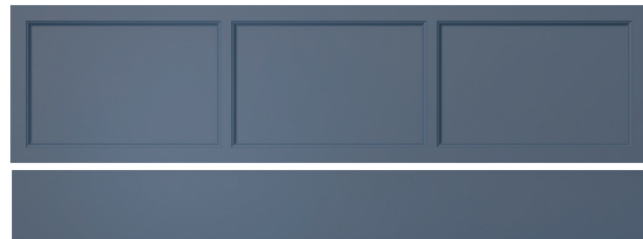

Maritime Blue

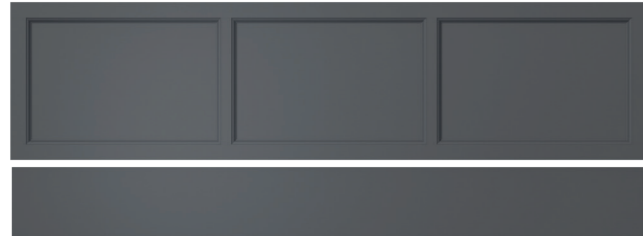

Graphite

### Front Panel 1800mm

Chantilly	KCHFP1800	£299
Maritime Blue	KMBFP1800	£299
Graphite	KGRFP1800	£299

### Front Panel 1700mm

Chantilly	KCHFP1700	£289
Maritime Blue	KMBFP1700	£289
Graphite	KGRFP1700	£289

All bath panels are supplied with a plinth as shown

### End Panel 700mm

Chantilly	KCHEP700	£145
Maritime Blue	KMBEP700	£145
Graphite	KGREP700	£145

### End Panel 750mm

Chantilly	KCHEP750	£150
Maritime Blue	KMBEP750	£150
Graphite	KGREP750	£150

### End Panel 800mm

Chantilly	KCHEP800	£155
Maritime Blue	KMBEP800	£155
Graphite	KGREP800	£155

All bath panels are supplied with a plinth as shown

## WC Seats

### Soft Close WC Seats

#### Chrome Finish Hinge

TSBLA101SC	Black	£142
TSGRA101SSC	Graphite	£139
TSDGR101SSC	Dove Grey	£139
TSCHA101SC	Chantilly	£139
TSMBL101SC	Maritime Blue	£139
TSOAK101SC	Oak	£142
TSWGL101SC	White Gloss	£142

### Soft Close WC Seats

#### Vintage Gold Finish Hinge

TSBLA100SC	Black	£139
TSGRA100SC	Graphite	£139
TSDGR100SC	Dove Grey	£139
TSCHA100SC	Chantilly	£139
TSMBL100SC	Maritime Blue	£139
TSOAK100SC	Oak	£139
TSWGL100SC	White Gloss	£139

### Soft Close WC Seats

#### Brushed Nickel Finish Hinge

TSBLA103SC	Black	£139
TSGRA103SC	Graphite	£139
TSDGR103SC	Dove Grey	£139
TSCHA103SC	Chantilly	£139
TSMBL103SC	Maritime Blue	£139
TSOAK103SC	Oak	£139
TSWGL103SC	White Gloss	£139

Adjustable soft close hinge seat will fit all British standard WCs.  
Quick release button for easy clean.



Black



Graphite



Dove Grey



Chantilly



Maritime Blue



Oak



White Gloss



# Sanitaryware



From timeless classics, Granley and Dorchester, alongside more modern options such as Stamford, or the elegant Hatton, explore the Heritage sanitaryware collection. We also offer beautifully crafted basins to fit our practical furniture pieces, and a Clinton pan to perfectly complement any storage solution.

Whichever you choose you can rest assured that all our sanitaryware will give you style and quality that lasts, that's why we offer a robust guarantee.



# Basins

Suites include basin options suitable for all bathroom spaces. Choose by type or style and select from pedestals, furniture or a washstand to complete the look.



**Standard**

Suitable for most bathroom spaces.



**Medium**

Slightly smaller than a standard, these are suitable for main bathrooms or an ensuite where space may be at a premium.



**Square**

Choose traditional styling with an angular twist.



**Cloakroom**

As the name suggests, these compact options are designed to work in smaller spaces.

## Basin - Options

Range	Standard	Medium	Square	Cloakroom	Baby	Corner	Vessel
Berkhamsted							✓
Chiswick							✓
Dorchester	✓		✓	✓	✓	✓	
Granley	✓	✓		✓	✓		
Keymer							✓
Hatton	✓						
Redford							✓
Stamford	✓	✓					



**Baby**

A petite option for even the smallest cloakroom.



**Corner**

Make the most of awkward or angular spaces with a corner basin.



**Vessel**

Suitable for use with vanity units and a worktop

## Dorchester basins

### Medium Basin & Pedestal

2 Taphole Basin	PDW06	£341
3 Taphole Basin	PDW063	£341
Pedestal	PDW09	£190

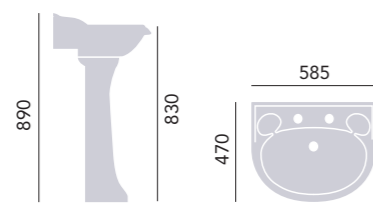

### Square Basin & Pedestal

2 Taphole Basin	PVEW05	£439
3 Taphole Basin	PVEW053	£439
Pedestal	PVEW09	£272

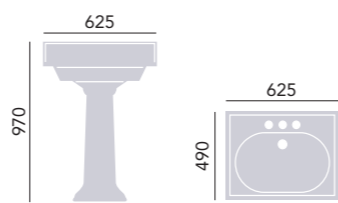

### Basin & Abingdon Washstand Chrome

2 Taphole Basin	PVEW05	£439
3 Taphole Basin	PVEW053	£439

### Washstands Chrome

Washstands	WSABDOR	£715
Glass Shelf	WGABDOR	£141
Towel Rail	WTABUNI	£134

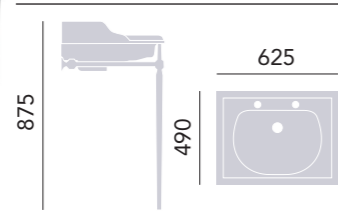

Use with a bottle trap.

### Basin & Abingdon Washstand Vintage Gold

2 Taphole Basin	PVEW05	£439
3 Taphole Basin	PVEW053	£439

### Washstands Vintage Gold

Washstands	WSABDORVG	£774
Glass Shelf	WGABDORVG	£158
Towel Rail	WTABUNIVG	£158

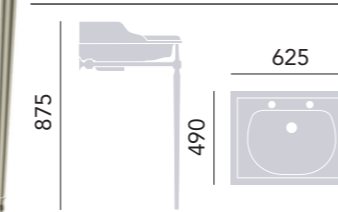

Use with a bottle trap.

## Dorchester Basins

### Cloakroom Basin & Pedestal

1 Taphole Basin	PDW071	£294
2 Taphole Basin	PDW07	£294
Pedestal	PDW09CL	£174

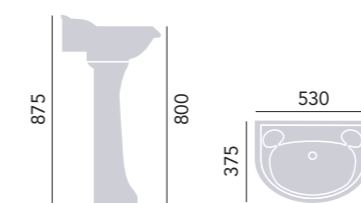

Hide pipework with a pedestal or use ornate brackets.

### Baby Basin

2 Taphole Basin	PDW08	£224
-----------------	-------	------



This basin is wall mountable only (wall brackets supplied). Use with short nose pillar taps, such as Dawlish. Use with a bottle trap.

### Corner Basin

2 Taphole Basin	PDW11	£299
-----------------	-------	------



Use with ornate brackets and a bottle trap.

## Granley Basins

### Standard Basin & Pedestal

2 Taphole Basin	PGRW05	£294
3 Taphole Basin	PGRW053	£294
Pedestal	PGRW09	£147

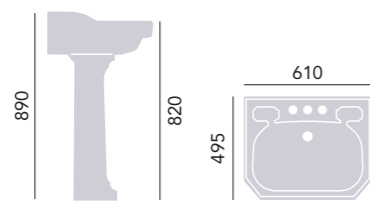

### Medium Basin & Pedestal

2 Taphole Basin	PGDW06	£263
Pedestal	PGRW09	£147



### Cloakroom Basin & Pedestal

1 Taphole Basin	PGRW071	£267
2 Taphole Basin	PGRW07	£267
Pedestal	PGRW09	£147

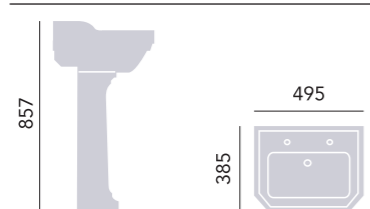

Use with Granley Pedestal to hide pipework or wall mount with brackets (not supplied).

### Baby Basin

2 Taphole Basin	PGRW08	£209
-----------------	--------	------



This basin is wall mountable only (wall brackets supplied). Use with a bottle trap.

## Stamford Basins

### Stamford 450mm Basin and Semi Pedestal

1 Tap Hole Basin	PSFW071	£145
Pedestal	PSFW10S	£95

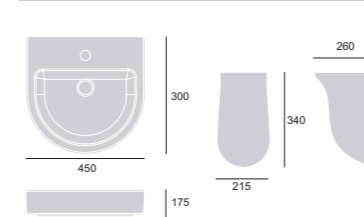

### Stamford 450mm Basin and Small Semi Pedestal

1 Tap Hole Basin	PSFW071	£145
Pedestal	PSFW10S	£90

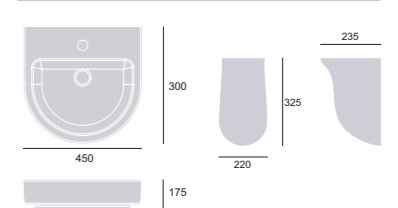

## Stamford & Hatton Basins

### Stamford 560mm Basin and Full Length Pedestal



1 Tap Hole Basin	PSFW051	£170
2 Tap Hole Basin	PSFW05	£175
3 Tap Hole Basin	PSFW053	£179
Pedestal	PSFW09	£109

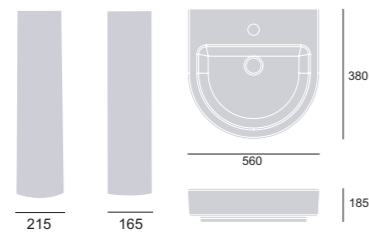

### Stamford 560mm Basin and Semi Pedestal



1 Tap Hole Basin	PSFW051	£170
2 Tap Hole Basin	PSFW05	£175
3 Tap Hole Basin	PSFW053	£179
Pedestal	PSFW10S	£95

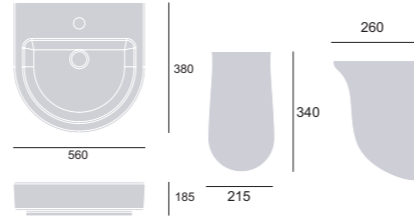

### Hatton 630mm Basin and Full Length Pedestal



1 Tap Hole Basin	PHAWW051	£203
2 Tap Hole Basin	PHAWW05	£208
3 Tap Hole Basin	PHAW053	£214
Pedestal	PHAW09	£124

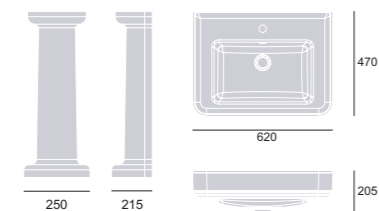

## Vessel Basins

### Redford Round Vessel Basin

Basin	PRFW10	£250
-------	--------	------

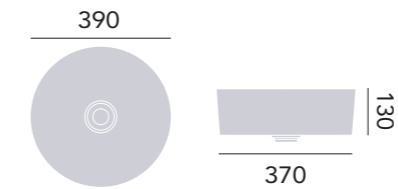

### Berkhamsted Oblong Vessel Basin

Basin	PBHW10	£300
-------	--------	------

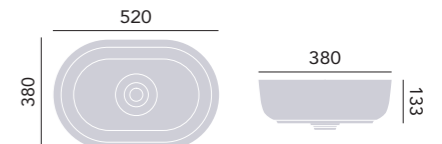

### Chiswick Vessel Basin

Basin	PCHW14	£294
-------	--------	------

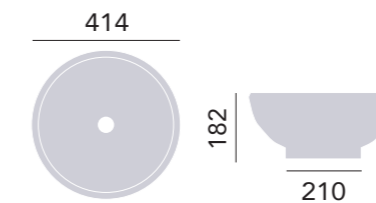

### Keymer Vessel Basin

Basin	PKMW10	£345
-------	--------	------



Available  
July 2023

# WCs

Just like our beautiful basin options, all of our suites include WC options. We also offer a Clinton back to wall pan to complement our furniture ranges.



### High Level

Make a statement with a high level cistern and ornate chain pull. High level options also require a flush pack.



### Low Level

A stylish traditional option with a separate pan and cistern connected by a flush pack.



### Close Coupled

A popular option, close coupled keep the pan and cistern together.

## WC - Options

Range	Wall hung	Back to wall	Close Coupled	Low Level	High Level
Clinton		✓			
Dorchester	✓		✓	✓	✓
Granley			✓	✓	✓
Hatton		✓	✓		
Stamford	✓	✓	✓		



### Cistern Levers

Choose from a range of cistern levers, find them on page 95.



### Toilet Seats

Our toilet seats are available in range of colours, including options to match our furniture finishes, see page 94.



### Back to Wall

Ideal with furniture, a back to wall uses a concealed cistern.



### Wall Hung

Create a simple, elegant look with a pan that uses a cistern hidden in the wall.

## Dorchester WC's

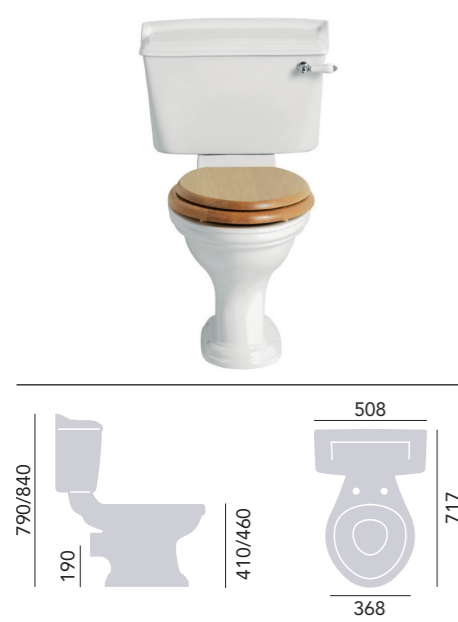

**Close Coupled WC & Landscape Cistern**

Standard Height WC	PDW00	£348
Comfort Height WC	PDWC00	£411
Landscape Cistern	PD2W01F	£338

Use with Heritage WC seat. Cistern price includes fittings. Cistern offers 6 litre single flush.

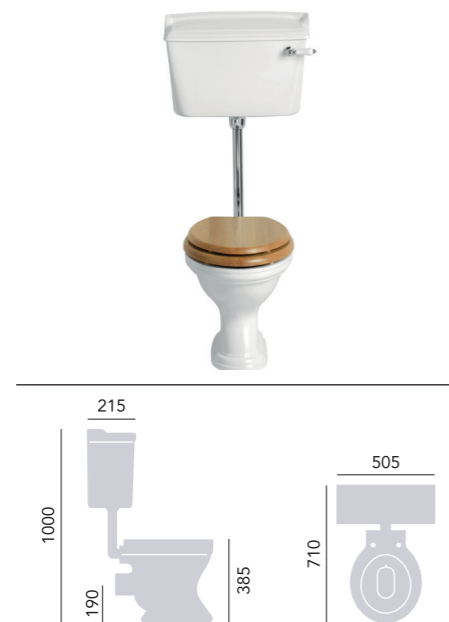

**Low Level WC and Cistern**

WC	PVEW00	£377
Low Level Cistern	PVE2W01F	£280

**Low Level Flush Pack**

Chrome	CC00	£181
Vintage Gold	CA00	£206

Use with Heritage WC Seat. Select your cistern lever from our range.



**High Level WC and Cistern**

WC	PVEW00	£377
High Level Cistern	PVE2W02F	£375

**High Level Flush Pack**

Chrome	CC01	£412
Vintage Gold	CA01	£469

Cistern price includes fittings. Shortening the length of the flushpipe may affect the efficiency of the flush. Use with Heritage WC Seat. Flush pack includes brackets and chain pull. Cistern offers 6/4 litre dual flush.

## Granley WC's



**Close Coupled Standard Height WC & Cistern**

WC	PGRW00	£299
Cistern	PGR2W01F	£287

Use with Heritage WC Seat. Cistern price includes fittings. Select your cistern lever from our range. Cistern offers 6/4 litre dual flush.



**Close Coupled WC & Landscape Cistern**

WC	PGRWOL	£327
Low Level Cistern	PGR2W01LF	£323

**Low Level Flush Pack**

Chrome	CC00	£181
Vintage Gold	CA00	£206

Use with Heritage WC Seat. Cistern price includes fittings. Select your cistern lever from our range. Cistern offers 6/4 litre dual flush.

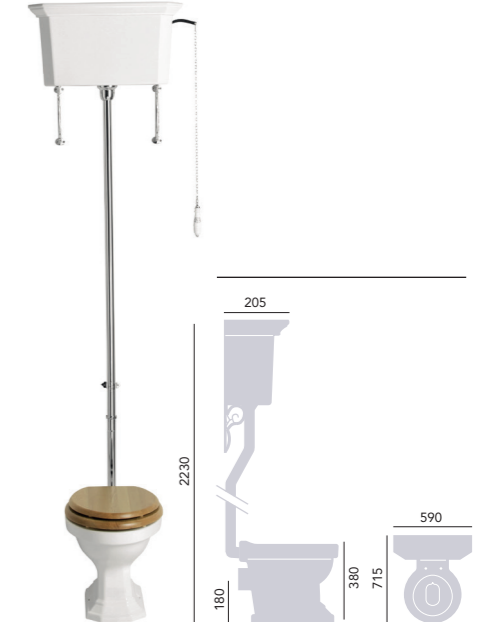

**High Level WC and Cistern**

WC	PGRWOL	£327
High Level Cistern	PGR2W02F	£429

**High Level Flush Pack**

Chrome	CC01	£412
Vintage Gold	CA01	£469

Cistern price includes fittings. Shortening the length of the flushpipe may affect the efficiency of the flush. Use with Heritage WC Seat. Flush pack includes brackets and chain pull. Cistern offers 6/4 litre dual flush.

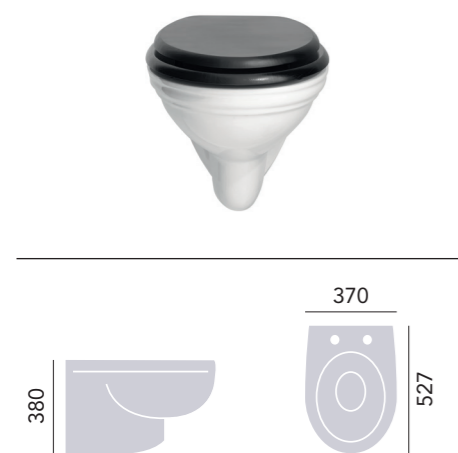

**Wall Hung WC**

WC	PDW00	£398
----	-------	------

Use with wall hung frame and concealed cistern CFC36 or CFC37. Use with Heritage WC seat.



**Wall Hung Frame & Concealed Cistern Front Access**

Frame & Concealed Cistern, Steel	CFC36	£376
----------------------------------	-------	------

These frames make a wall hung WC easier to install.



**Tall Wall Hung Frame & Concealed Cistern Front Access**

Frame & Concealed Cistern, Steel	CFC37	£376
----------------------------------	-------	------

These frames make a wall hung WC easier to install.

## Stamford WC's

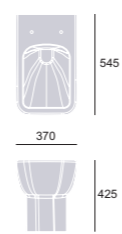
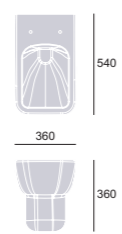
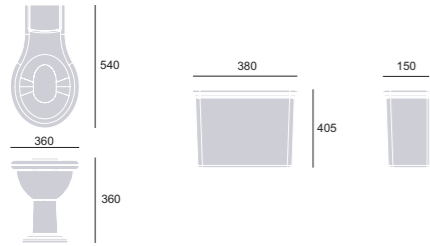

### Close Coupled Pan & Dual Flush CC Cistern

WC Cistern	PSFW00	£295
Toilet Seat	PSFW02	£155
	TSWGL2	£129

Cistern offers a 6/4 litre dual flush.

### Stamford Wall Hung Pan

WC	PSFW00	£325
Toilet Seat	TSWGL2	£129

### Stamford Back-To-Wall Pan

WC Concealed Cistern and Push Button Toilet Seat	PSFW00	£325
	CFC32	£118
	TSWGL2	£129

For use with Heritage Back to Wall WCs with WC furniture units.

## Hatton & Clinton WC's

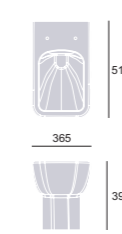
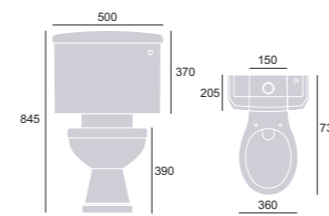

### Close Coupled Pan & Dual Flush Cistern

WC Cistern	PHAW00	£224
	PHAW01	£190

### Hatton Back-To-Wall Pan

WC Concealed Cistern and Push Button	PHAW00	£422
	CFC32	£118

For use with Heritage Back to Wall WCs with WC furniture units.



### Concealed Cistern and Push Button

CFC32	£118
-------	------

For use with Heritage Back to Wall WCs with WC furniture units.

### Wall Hung Frame & Concealed Cistern Front Access

Frame & Concealed Cistern, Steel	CFC36	£376
----------------------------------	-------	------

These frames make a wall hung WC easier to install.

### Tall Wall Hung Frame & Concealed Cistern Front Access

Frame & Concealed Cistern, Steel	CFC37	£376
----------------------------------	-------	------

These frames make a wall hung WC easier to install.

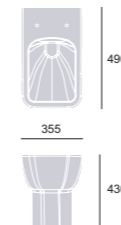

### Clinton Back-To-Wall Pan

WC Toilet Seat	PCNW00	£259
	TSWGL1	£99

Use with CFC32



## WC Seats



Black



Graphite



Dove Grey



Chantilly



Maritime Blue



Oak



White Gloss

### Soft Close WC Seats

#### Chrome Finish Hinge

TSBLA101SC	Black	£142
TSGRA101SSC	Graphite	£139
TSDGR101SSC	Dove Grey	£139
TSCHA101SC	Chantilly	£139
TSMBL101SC	Maritime Blue	£139
TSOAK101SC	Oak	£142
TSWGL101SC	White Gloss	£142

### Soft Close WC Seats

#### Vintage Gold Finish Hinge

TSBLA100SC	Black	£139
TSGRA100SC	Graphite	£139
TSDGR100SC	Dove Grey	£139
TSCHA100SC	Chantilly	£139
TSMBL100SC	Maritime Blue	£139
TSOAK100SC	Oak	£139
TSWGL100SC	White Gloss	£139

### Soft Close WC Seats

#### Brushed Nickel Finish Hinge

TSBLA103SC	Black	£139
TSGRA103SC	Graphite	£139
TSDGR103SC	Dove Grey	£139
TSCHA103SC	Chantilly	£139
TSMBL103SC	Maritime Blue	£139
TSOAK103SC	Oak	£139
TSWGL103SC	White Gloss	£139

*Adjustable soft close hinge seat will fit all British standard WCs.  
Quick release button for easy clean.*

## Cistern Levers



### Traditional Cistern Lever

Chrome CPC00



### Traditional Cistern Lever

Vintage Gold CPA00



### Deco Cistern Lever

Chrome CDC01 £27

# Baths



Discover the perfect bath to complement your personal style from one of the largest collections of freestanding baths available.

Manufactured to the highest standards, all our baths are built to superior specifications and come with a lifetime guarantee.



# Cast Iron Baths



These beautiful baths are the perfect statement piece.

Our cast iron baths are built to superior specifications and will arrive primed and ready to paint. The inside is also immaculately finished – coated with two layers of grade AA white ripple enamel for a pristine finish.



## Freestanding Cast Iron Baths

### Baby Buckingham Cast Iron Double Ended Bath

Internal length 1410mm  
 Internal width 620mm  
 Height inc. feet 585mm  
 Weight 119kg  
 Overflow to waste 370mm  
 Water capacity 170ltr

**1540 x 780mm**

2 taphole BRT88  
 No taphole BRT87

#### Including Imperial Feet

Cast Iron +BRT82 **£2419**  
 Chrome +BRT84 **£2559**

*Price includes bath and feet. No taphole bath with Imperial Feet shown. For waste options, choose from THC21 or THC16 with THC15CI.*

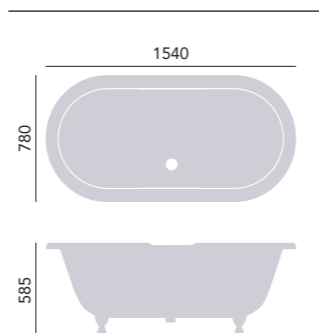

### Buckingham Cast Iron Double Ended Bath

Internal length 1560mm  
 Internal width 620mm  
 Height inc. feet 585mm  
 Weight 133kg  
 Overflow to waste 372mm  
 Water capacity 200ltr

**1700 x 770mm**

2 taphole BRT80  
 No taphole BRT79

#### Including Imperial Feet

Cast Iron +BRT82 **£2882**  
 Chrome +BRT84 **£2962**

*Price includes bath and feet. 2 taphole bath with Imperial Feet shown. For waste options, choose from THC21 or THC16 with THC15CI.*

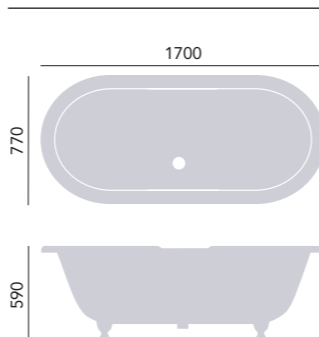

### Grand Buckingham Cast Iron Double Ended Bath

Internal length 1640mm  
 Internal width 660mm  
 Height inc. feet 675mm  
 Weight 152kg  
 Overflow to waste 465mm  
 Water capacity 240ltr

**1780 x 800mm**

2 taphole BRT85  
 No taphole BRT86

#### Including Grand Imperial Feet

Cast Iron +BRT90 **£3091**  
 Chrome +BRT91 **£3231**

*Price includes bath and feet. No taphole bath with Grand Imperial Feet shown. For waste options, choose from THC21 or THC16 with THC15CI.*

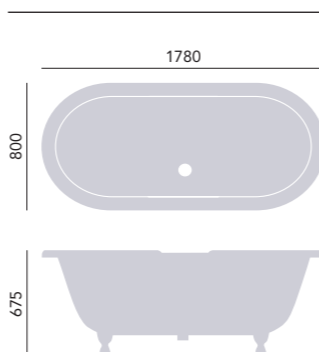

## Freestanding Cast Iron Baths

### Essex Cast Iron Single Ended Bath

Internal length 1580mm  
 Internal width 615mm  
 Height inc. feet 610mm  
 Weight 141kg  
 Overflow to waste 390mm  
 Water capacity 205ltr

**1700 x 770mm**

2 taphole BRT20  
 No taphole BRT00

#### Including Heritage Feet

Cast Iron +BRT02 **£2068**  
 Chrome +BRT12 **£2161**

#### Including Imperial Feet

Cast Iron +BRT22 **£2249**  
 Chrome +BRT24 **£2389**

*Price includes bath and feet. Essex 2 taphole bath with Imperial Feet shown here. See page 102 for additional feet options. For waste options, choose from THC21 or THC16 with THC15CI.*

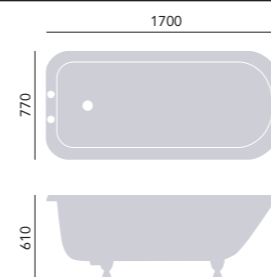

### Devon Cast Iron Double Ended Bath

Internal length 1645mm  
 Internal width 610mm  
 Height inc. feet 790mm  
 Weight 144kg  
 Overflow to waste 367mm  
 Water capacity 190ltr

**1800 x 770mm**

2 taphole BRT40  
 No taphole BRT44

#### Including Devon Feet

Cast Iron +BRT41 **£3428**  
 Chrome +BRT43 **£3568**

*Price includes bath and feet. Use with Devon Bath Feet only. 2 taphole bath with Devon Feet shown here. For waste options, choose from THC21 or THC16 with THC15CI, all on p111.*

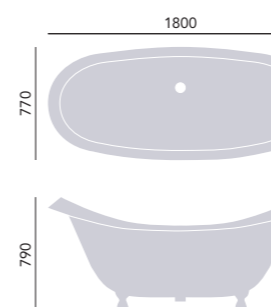

## Cast Iron Bath Feet



### Buckingham Imperial Large Ball & Claw Freestanding Bath Feet

Cast Iron	BRT82	£533
Chrome	BRT84	£673

*Use with Essex and Buckingham baths only. Cast iron feet can be painted to match the bath colour.*



### Grand Imperial Large Griffin Feet

Cast Iron	BRT90	£533
Chrome	BRT91	£673

*Use with Grand Buckingham bath only. Cast iron feet can be painted to match the bath colour.*



### Devon Large Lion's Paw Freestanding Bath Feet

Cast Iron	BRT41	£533
Chrome	BRT43	£673

*Use with Devon bath only. Cast iron feet can be painted to match the bath colour.*



### Heritage Small Ball & Claw Freestanding Bath Feet

#### Essex Heritage

Cast Iron	BRT02	£352
Chrome	BRT12	£445

*Use with Essex baths only. Cast iron feet can be painted to match the bath colour.*



### Imperial Large Ball & Claw Freestanding Bath Feet

#### Essex Imperial

Cast Iron	BRT22	£533
Chrome	BRT24	£673

*Use with Essex bath only. Cast iron feet can be painted to match the bath colour.*



# Acrylic Baths



Our acrylic baths are durable, adaptable and stylish. With a lightweight but rigid construction they're hard-wearing but easy to manoeuvre.

Choose a freestanding acrylic in a range of shapes and styles, as well as options with a statement finishes like metallic effects, or marble.

Or, for more practical spaces like a family bathroom where a shower and bath is needed in a limited space, a fitted acrylic bath can be the perfect solution.



## Statement Freestanding Acrylic Baths

### Hylton Metallic Effect Freestanding Acrylic Double Ended Bath

Height max 750mm  
Weight 49kg  
Overflow to waste 360mm  
Water capacity 200ltr

1735 x 730mm

Stainless Steel Effect BHYFS00STL **£3373**  
Gold Effect BHYFS00GLD **£3373**  
Copper Effect BHYFS00COP **£3373**

*Each bath is individually finished with real metallic leaf and coated with a high gloss acrylic surface. Clicker waste and overflow is included in either white or chrome. Use with THC15CI.*



Copper Effect



Gold Effect



Stainless Steel Effect

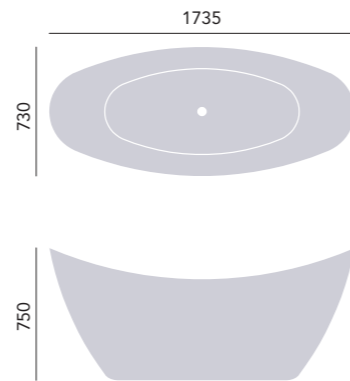

### Hollywell Metallic Effect Freestanding Acrylic Double Ended Bath

Height max 735mm  
Weight 54kg  
Overflow to waste 360mm  
Water capacity 160ltr

1705 x 745mm

Stainless Steel Effect BHOF00STL **£3244**  
Gold Effect BHOF00GLD **£3244**  
Copper Effect BHOF00COP **£3244**

*Each bath is individually finished with real metallic leaf and coated with a high gloss acrylic surface. Clicker waste and overflow is included in either white or chrome. Use with THC15CI.*



Gold Effect



Copper Effect



Stainless Steel Effect

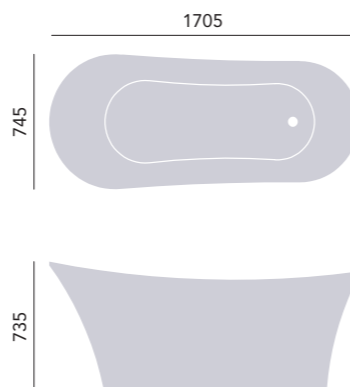

## Statement Freestanding Acrylic Baths

### Alderley Mock Croc Skin Effect Freestanding Acrylic Double Ended Bath

Height max 750mm  
Weight 49kg  
Overflow to waste 360mm  
Water capacity 200ltr

1735 x 730mm

Mock Croc Effect BALFS00CRC **£3503**

*Clicker waste and overflow is included in either white or chrome. Use with THC15CI.*

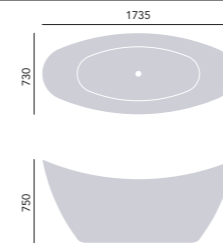

### Osterley Matt Black Effect Freestanding Acrylic Double Ended Bath

Height max 750mm  
Weight 49kg  
Overflow to waste 360mm  
Water capacity 200ltr

1735 x 730mm

Black BOSTFS00BLK **£3244**

*Clicker waste and overflow is included in either white or chrome. Use with THC15CI.*

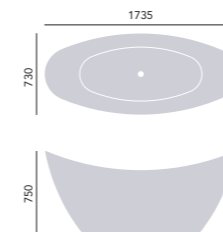

### Wenlock Marble Effect Freestanding Acrylic Double Ended Bath

Height max 750mm  
Weight 49kg  
Overflow to waste 360mm  
Water capacity 200ltr

1735 x 730mm

This bath is hand finished, colour and pattern may vary.

BWENFS00MBL **£3212**

*Clicker waste and overflow is included in either white or chrome. Use with THC15CI.*

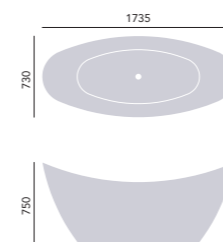

## Freestanding Acrylic Baths

### Edvin Freestanding Acrylic Double Ended Bath

Height inc. feet 670mm  
 Weight 46.75kg  
 Overflow to waste 370mm  
 Water capacity 170ltr

**1750 x 745**  
 No taphole      BEDFSW00      **£2335**

*Clicker waste and overflow is included in either white or chrome. Use with THC15CI.*

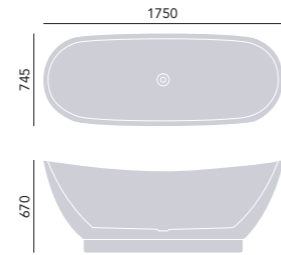

## Freestanding Acrylic Baths

### Baby Oban Freestanding Acrylic Double Ended Roll Top Bath

Height inc. feet 620mm  
 Weight 35kg  
 Overflow to waste 360mm  
 Water capacity 163ltr

**1495 x 795mm with Chrome Feet**  
 2 taphole      BBOFSW00 + BFOBC      **£1151**

*For waste options select THC16 with THC15CI.*

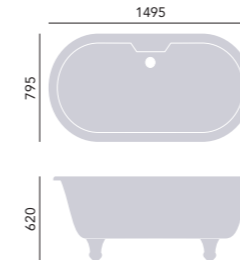

### Pomeroy Freestanding Acrylic Double Ended Bath

Height inc. feet 750mm  
 Weight 49kg  
 Overflow to waste 360mm  
 Water capacity 200ltr

**1735 x 730mm**  
 No taphole      BPOFSW00      **£2400**

*Clicker waste and overflow is included in either white or chrome. Use with THC15CI.*

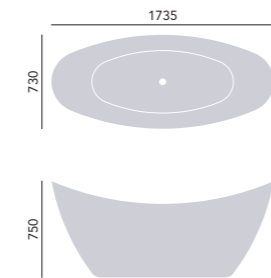

### Oban Freestanding Acrylic Double Ended Roll Top Bath

Height inc. feet 700mm  
 Weight 66kg  
 Overflow to waste 330mm  
 Water capacity 205ltr

**1760 x 760mm with Chrome Feet**  
 2 taphole      BOBW01 + BFOBC      **£1222**

*For waste options select THC16 with THC15CI.*

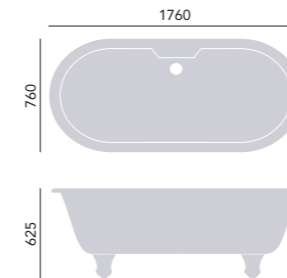

### Lydford Freestanding Acrylic Slipper Bath

Height inc. feet 800mm  
 Weight 48kg  
 Overflow to waste 390mm  
 Water capacity 226ltr

**1660 x 800mm**  
 No taphole      BLFFSW00      **£2205**

*Clicker waste and overflow is included in either white or chrome. Use with THC15CI. Cannot be fitted with a standard waste trap unless waste is fitted below floor level or if the bath is positioned on a raised floor or plinth.*

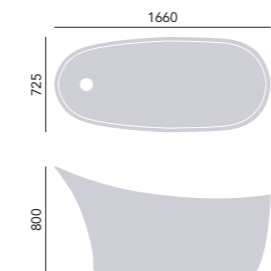

### Perth Freestanding Acrylic Single Ended Roll Top Bath

Height inc. feet 605mm  
 Weight 38.2kg  
 Overflow to waste 360mm  
 Water capacity 185ltr

**1650 x 720mm with Chrome Feet**  
 2 taphole      BPHW01 + BFPHC      **£1203**

*Cannot be fitted with a standard waste trap unless the waste is fitted below floor level, if the bath is positioned on a raised floor or plinth, or used with shallow trap waste THC15CI with THC16.*

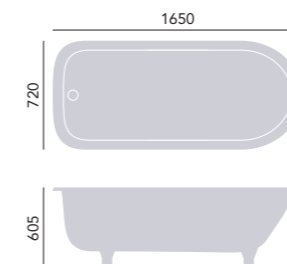



## Freestanding Acrylic Baths

### Grantham Freestanding Acrylic Single Ended Slipper Bath

Height inc. feet 730mm  
 Weight 40.4kg  
 Overflow to waste 345mm  
 Water capacity 165ltr

#### 1550 x 670mm with Chrome Feet

No taphole                      BGRFSW00 + BFGRC                      **£1131**

*Clicker waste and overflow is included in either white or chrome. Use with THC15CI. Cannot be fitted with a standard waste trap unless waste is fitted below floor level or if the bath is positioned on a raised floor or plinth.*

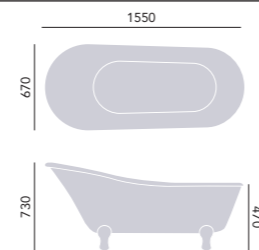

## Freestanding Acrylic Baths

### Tilbury Corner Freestanding Single Ended Bath

Height inc. feet 595mm  
 Weight 41kg  
 Overflow to waste 350mm  
 Water capacity 185ltr

#### Left Hand

No taphole in White                      BTIFSWOOL + BTIFC                      **£1248**

#### Right Hand

No taphole in White                      BTIFSWOOR + BTIFC                      **£1248**

*Price includes chrome feet. Use with a bath screen. For decorative waste options use THC16 and THC15CI. Please note this bath is not suitable for use with bath shower mixers due to the space required for the handset, so deck or wall mounted bath fillers are recommended for this product.*

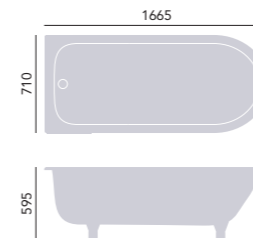

### Derrymore Freestanding Acrylic Double Ended Roll Top Bath

Height inc. feet 590mm  
 Weight 58kg  
 Overflow to waste 375mm  
 Water capacity 190ltr

#### 1735 x 790mm

No taphole                      BVEFSW00                      **£2271**

*Clicker waste and overflow is included in either white or chrome. Use with THC15CI.*

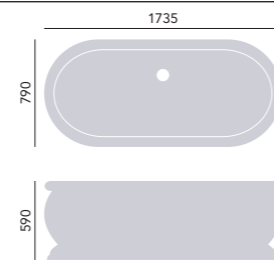

### Orford Freestanding Acrylic Double Ended Bath

Height inc. feet 700mm  
 Weight 66kg  
 Overflow to waste 370mm  
 Water capacity 190ltr

#### 1700 x 740mm

No taphole                      BORFSW00                      **£2400**

*Clicker waste and overflow is included in either white or chrome. Use with THC15CI.*

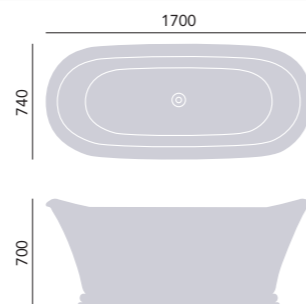

**Tilbury - choosing the correct option**

If your bath is to feature in a left hand corner please choose the left hand option.  
 If your bath is to feature in a right hand corner please choose the right hand option.

## Fitted Acrylic Baths

### 1700 x 700mm Solid Skin Acrylic Single Ended Fitted Bath

Height inc. feet  
Weight 30.77kg  
Overflow to waste 310mm  
Water capacity 202ltr

No taphole      BHPW1770S      **£642**

*Comes with adjustable feet. Please order bath panels separately and use with a bath screen.*

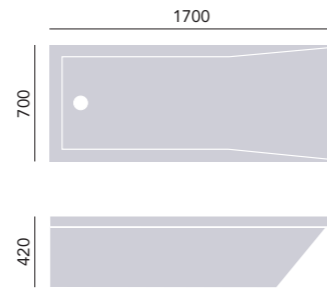

## Fitted Acrylic Baths

### 1700 x 700mm Solid Skin Acrylic Single Ended Fitted Bath

Internal length 1470mm  
Internal width 540mm  
Height 430mm  
Overflow to waste 285mm  
Water capacity 200ltr

2 taphole      BGDW1770S      **£642**

*Comes with adjustable feet. Please order bath panels separately and use with a bath screen.*

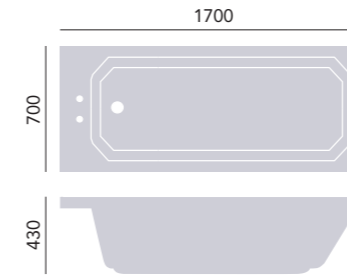

### 1700 x 750mm Solid Skin Acrylic Double Ended Fitted Bath

Height inc. feet  
Weight 32.77kg  
Overflow to waste 370mm  
Water capacity 200ltr

No taphole      BHPW1775D      **£782**

*Comes with adjustable feet. Please order bath panels separately and use with a bath screen.*

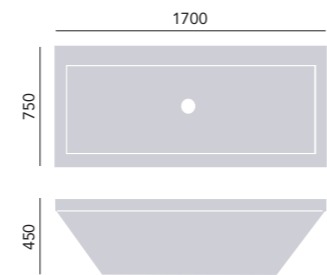

### 1700 x 750mm Solid Skin Acrylic Single Ended Fitted Bath

Internal length 1449mm  
Internal width 562mm  
Height 385mm  
Overflow to waste 300mm  
Water capacity 205ltr

2 taphole      BGRW1775S      **£728**

*Comes with adjustable feet. Please order bath panels separately and use with a bath screen.*

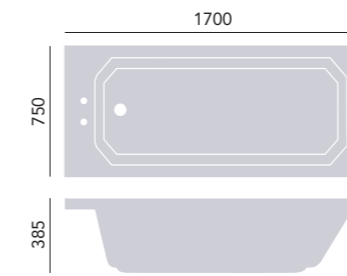

### 1800 x 800mm Solid Skin Acrylic Double Ended Fitted Bath

Height inc. feet  
Weight 34.77kg  
Overflow to waste 375mm  
Water capacity 220ltr

No taphole      BHPW1880D      **£854**

*Comes with adjustable feet. Please order bath panels separately and use with a bath screen.*

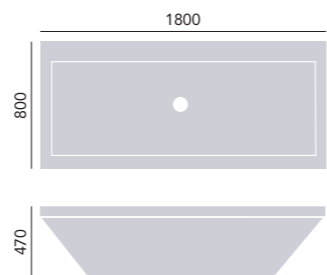

### 1800 x 800mm Solid Skin Acrylic Double Ended Fitted Bath

Internal length 1645mm  
Internal width 650mm  
Height 385mm  
Overflow to waste 280mm  
Water capacity 225ltr

2 taphole      BGRW1880D      **£861**

*Comes with adjustable feet. Please order bath panels separately and use with a bath screen.*

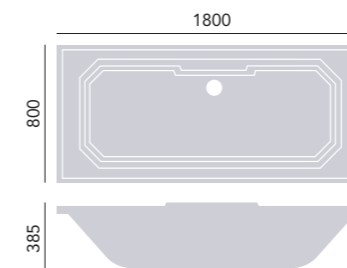

## Baths Screens



### Sherborne Curved Bath Screen

Height 1400mm  
Width 780mm  
Depth 6mm

Bath Screen SBSHE05 £273

*Compatible with all fitted baths. Reversible for left or right handed fitting. Chrome hinge and fixings.*

## Wastes & Extras



### Bath Waste

Chrome	THC11	£30
Vintage Gold	THA11	£42
Brushed Nickel	THBN11	£39



### Ornate Bath Waste

Chrome	THC11P	£42
Vintage Gold	THA11P	£59

*Porcelain plug.*



### Bath Pop Up Waste

Chrome	THC14	£42
Vintage Gold	THA14	£63
Brushed Nickel	THBN14	£59
Brushed Brass	THBB14	£59
Matt Black	THBL14	£59

*Not suitable for use with freestanding baths.*



### Push Button Bath Waste

Chrome	THC22	£77
Vintage Gold	THA22	£85
Brushed Nickel	THBN22	£79
Brushed Brass	THBB22	£79
Matt Black	THBL22	£79

*Easy to operate push button bath waste and overflow cover.*



### Exposed Push Button Bath Waste and Overflow Kit

Chrome	THC21	£245
Brushed Nickel	THBN21	£250
Brushed Brass	THBB21	£250
Matt Black	THBL21	£250

*Decorative overflow and waste kit for use with freestanding baths. Includes overflow cover and push button bath waste.*



## Wastes & Extras



### Standpipes

Chrome	THC20	£469
Vintage Gold	THA20	£578
Brushed Nickel	THBN20	£318

Decorative pipework designed to support taps or mixers near freestanding baths and conceal the water pipes fed from under the floor. Standpipes can be cut down to size to fit your chosen bath. Use with baths without tapholes. Height 670mm. Use with taps that have separate legs.



### Shrouds

Chrome	THC30	£289
Vintage Gold	THA30	£386
Brushed Nickel	THBN30	£516

Decorative pipework to conceal water pipes fed from under the floor to the bath mounted taps and mixers. Shrouds can be cut down to size to fit your chosen bath. Use with baths with tapholes. Height 600mm.



### Exposed Bath Waste & Overflow

Chrome	THC16	£129
Vintage Gold	THA16	£181
Brushed Nickel	THBN16	£169
Chrome	THC16P	£143
Vintage Gold	THA16P	£181

Decorative overflow and waste kit for use with freestanding baths. 'P' suffix codes include a porcelain plug.



### Exposed Shallow Bath Trap

Chrome	THC15CI	£116
Vintage Gold	THA15CI	£143
Brushed Nickel	THBN15CI	£135

Decorative waste pipe and trap to use instead of plastic pipe beneath freestanding baths.



## Bath Front Panels

### Front Panel 1800mm

Chantilly	KCHF1800	£299
Maritime Blue	KMBFP1800	£299
Graphite	KGRFP1800	£299

### Front Panel 1700mm

Chantilly	KCHF1700	£289
Maritime Blue	KMBFP1700	£289
Graphite	KGRFP1700	£289

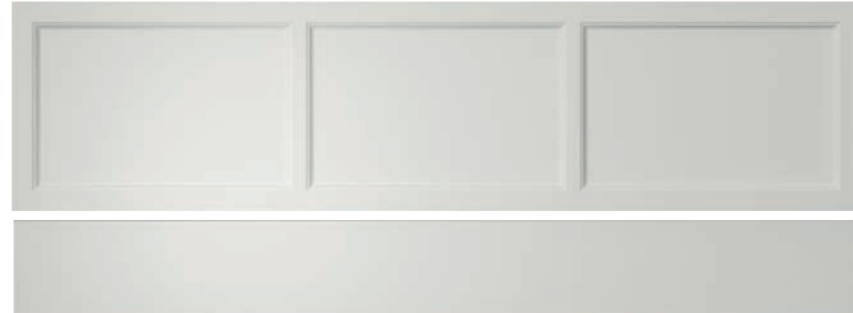

Chantilly



Maritime Blue

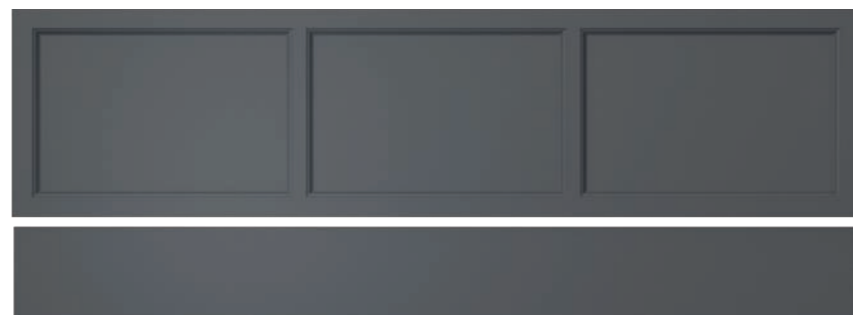

Graphite

## Bath End Panels

### End Panel 700mm

Chantilly	KCHEP700	£145
Maritime Blue	KMBEP700	£145
Graphite	KGREP700	£145

### End Panel 750mm

Chantilly	KCHEP750	£150
Maritime Blue	KMBEP750	£150
Graphite	KGREP750	£150

### End Panel 800mm

Chantilly	KCHEP800	£155
Maritime Blue	KMBEP800	£155
Graphite	KGREP800	£155

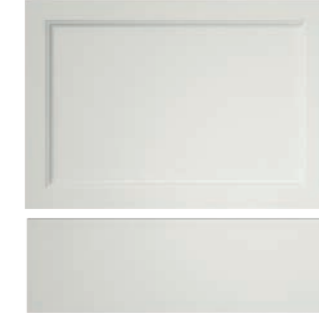

Chantilly

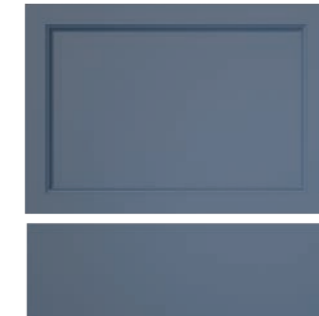

Maritime Blue



Graphite

# Taps & Showers

Our taps and showers are designed to sit beautifully in your bathroom.  
With market leading guarantees choose from our six tap ranges.

Each with matching shower options, or opt for the indulgent Avenbury,  
a standalone statement shower (page 124).

You can also choose from five on-trend finishes:



### Chrome

A classic, elegant finish available on all our taps and showers.



### Vintage Gold

A gentle gold for an understated look.



### Brushed Nickel

A soft brushed finish, perfect for calming bathroom spaces.



### Brushed Brass

A rich and opulent on trend finish.



### Matt Black

The perfect option for a sleek look, make a bold statement with a matching black shower.

## Taps - Type

Range	1TH Basin Mixer	3TH Basin Mixer	3TH Swivel Spout Basin Mixer	Basin Pillar Taps	Tall Basin Mixer	3TH Wall Mounted Basin Mixer	2TH Wall Mounted Basin Mixer	Small Basin Taps	Bath Pillar Taps	Bath Filler	3TH Bath Filler	Bath Shower Mixer	Floor Standing BSM
Dartmouth	✓	✓		✓	✓	✓	✓		✓	✓		✓	
Dawlish	✓	✓		✓				✓	✓	✓		✓	
Hartlebury	✓	✓	✓	✓					✓	✓		✓	
Glastonbury	✓	✓	✓	✓					✓	✓		✓	
Salcombe	✓	✓		✓	✓	✓			✓	✓		✓	✓
Trinity	✓	✓		✓					✓	✓	✓	✓	

## Showers - Type

Range	Recessed				Exposed			
	With Riser Kit	With Fixed Head	With Fixed Head and Riser Kit	Valve Only	With Riser Kit	With Fixed Riser Kit	With Fixed Riser and Diverter to Handset	Valve Only
Avenbury							✓	
Dartmouth			✓					
Dawlish	✓	✓	✓	✓	✓		✓	✓
Glastonbury		✓	✓	✓	✓	✓		✓
Hartlebury		✓	✓	✓	✓	✓		✓
Salcombe			✓	✓				
Trinity			✓				✓	

## Taps & Showers - Finishes

Range	Chrome	Vintage Gold	Brushed Nickel	Brushed Brass	Matt Black
Avenbury	✓				
Dartmouth	✓			✓	✓
Dawlish	✓	✓	✓		
Glastonbury	✓	✓	✓		
Hartlebury	✓	✓			
Salcombe	✓			✓	✓
Trinity	✓				

## Avenbury

### Exposed Shower with Deluxe Fixed Riser Kit & Diverter to Handset

Extra large 8" shower rose. Deluxe handset and soap basket. Stylish wide bore rigid riser for optimised flow. Working pressure range: 0.1 - 5.0 bar.

Chrome AVEDUAL01 £1391

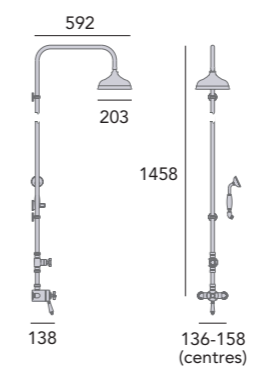

Working pressure range: Min: 0.2 Max: 5.0



## Dartmouth Basin Taps



### 1 Taphole Basin Mixer

Spout Projection 120mm  
Full height 177mm  
Min. operating pressure 0.5bar  
Valve: Ceramic cartridge

Chrome	TDACC04	£225
Brushed Brass	TDACBB04	£269
Matt Black	TDACBL04	£269

### 3 Taphole Basin Mixer

Spout Projection 120mm  
Full height 234mm  
Min. operating pressure 0.5bar  
Valve: Quarter turn ceramic disc

Chrome	TDACC06	£325
Brushed Brass	TDACBB06	£399
Matt Black	TDACBL06	£399

### 3 Taphole Wall Mounted Basin Mixer

Spout Projection 179mm  
Full height 72mm  
Min. operating pressure 0.5bar  
Valve: Quarter turn ceramic disc

Chrome	TDACC310	£325
Brushed Brass	TDACBB310	£419
Matt Black	TDACBL310	£419



### 2 Taphole Wall Mounted Basin Mixer

Spout Projection 160-185mm  
Full height 88mm  
Min. operating pressure 0.5bar  
Valve: Ceramic cartridge

Chrome	TDACC210	£299
Brushed Brass	TDACBB210	£369
Matt Black	TDACBL210	£369

### Basin Pillar Taps

Spout Projection 100mm  
Full height 127mm  
Min. operating pressure 0.5bar  
Valve: Quarter turn ceramic disc

Chrome	TDACC00	£175
Brushed Brass	TDACBB00	£199
Matt Black	TDACBL00	£199

### Tall Basin Mixer

Spout Projection 145mm  
Full height 289mm  
Min. operating pressure 0.5bar  
Valve: Ceramic cartridge

Chrome	TDACCT04	£279
Brushed Brass	TDACBBT04	£325
Matt Black	TDACBLT04	£325

## Dartmouth Bath Taps



### Bath Filler

Spout Projection 115mm  
Full height 237mm  
Min. operating pressure 0.2bar  
Valve: Quarter turn ceramic disc

Chrome	TDACC07	£409
Brushed Brass	TDACBB07	£425
Matt Black	TDACBL07	£425

### Bath Pillar Taps

Spout Projection 100mm  
Full height 137mm  
Min. operating pressure 0.2bar  
Valve: Quarter turn ceramic disc

Chrome	TDACC01	£199
Brushed Brass	TDACBB01	£225
Matt Black	TDACBL01	£225

### Bath Shower Mixer

Spout Projection 115mm  
Full height 237mm  
Min. operating pressure 0.5bar  
Valve: Quarter turn ceramic disc

Chrome	TDACC02	£475
Brushed Brass	TDACBB02	£549
Matt Black	TDACBL02	£549





## Dartmouth Shower

### Dartmouth Concealed Shower with Fixed Head and Flexible Kit

Chrome	SDACDUAL01	£799
Brushed Brass	SDACDUAL02	£919
Matt Black	SDACDUAL03	£919

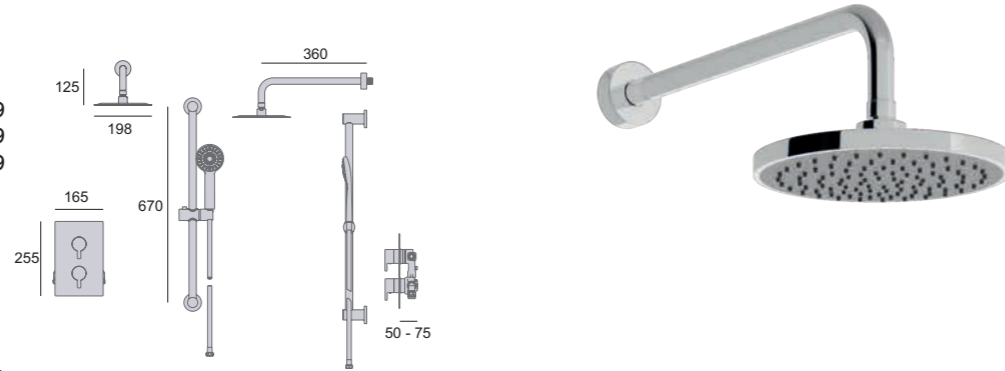

Working pressure range: Min. 0.2, Max. 5.0 Bar



## Dawlish Taps



### 3 Taphole Basin Mixer

Spout Projection 130mm  
Full height 85mm  
Min. operating pressure 0.2bar  
Valve: Quarter turn ceramic disc

Chrome	TDCC06	£323
Vintage Gold	TDCG06	£399
Brushed Nickel	TDCN06	£355

### Basin Pillar Taps

Spout Projection 95mm  
Full height 125mm  
Min. operating pressure 0.1bar  
Valve: Quarter turn ceramic disc

Chrome	TDCC00	£123
Vintage Gold	TDCG00	£162
Brushed Nickel	TDCN00	£145

### Short Nose Basin Pillar Taps

Spout Projection 67mm  
Full height 115mm  
Min. operating pressure 0.1bar  
Valve: Quarter turn ceramic disc

Chrome	TDCCS00	£111
Vintage Gold	TDCGS00	£142
Brushed Nickel	TDCNS00	£125

### 1 Taphole Basin Mixer

Spout Projection 170mm  
Full height 110mm  
Min. operating pressure 0.1bar  
Valve: Quarter turn ceramic disc

Chrome	TDCC04	£225
Vintage Gold	TDCG04	£284
Brushed Nickel	TDCN04	£249

Includes pop-up waste.

Taps with shorter spouts are ideal for small basins, such as the Dorchester and Granley Baby Basin.

Includes pop-up waste.



### Bath Filler

Spout Projection 247mm  
Full height 230mm  
Min. operating pressure 0.2bar  
Valve: Quarter turn ceramic disc

Chrome	TDCC072	£355
Vintage Gold	TDCG072	£438
Brushed Nickel	TDCN07	£389

### Bath Pillar Taps

Spout Projection 87mm  
Full height 130mm  
Min. operating pressure 0.2bar  
Valve: Quarter turn ceramic disc

Chrome	TDCC01	£142
Vintage Gold	TDCG01	£181
Brushed Nickel	TDCN01	£159

### Bath Shower Mixer

Spout Projection 247mm  
Full height 340mm  
Min. operating pressure 0.2bar  
Valve: Quarter turn ceramic disc

Chrome	TDCC02	£418
Vintage Gold	TDCG02	£540
Brushed Nickel	TDCN02	£479

Can be deck mounted or used with standpipes on a freestanding bath.

Can be used with standpipes or shrouds on a freestanding bath.

## Dawlish Showers

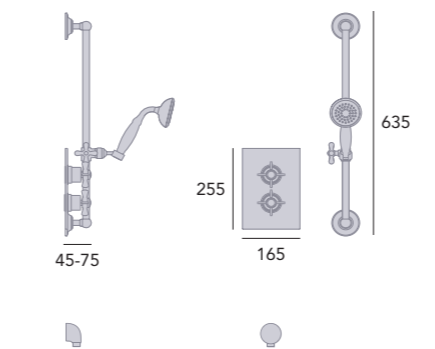

Working pressure range: Min. 0.2, Max. 5.0 Bar

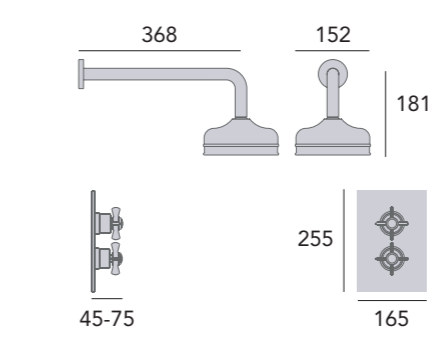

Working pressure range: Min. 0.2, Max. 5.0 Bar

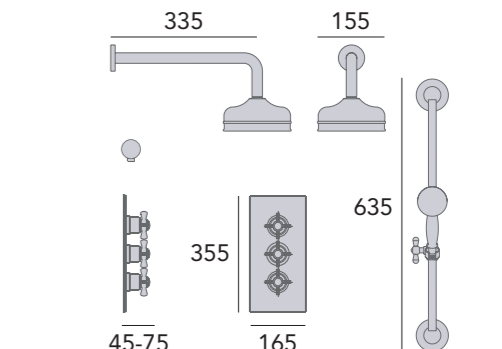

Working pressure range: Min. 0.2, Max. 5.0 Bar

### Recessed Shower with Premium Flexible Riser Kit

Valve will fit in a 35mm cavity space. Hose outlet included. Ceramic Disc.

Chrome	SDCDUAL01	£700
Brushed Nickel	SDCDUAL11	£715

If you like this valve but want to choose different accessories, use the below code and see our kits on p148.

Chrome	SDCO4	£496
--------	-------	------

### Recessed Shower with Premium Fixed Head Kit

Large 6" shower rose. Valve will fit in a 35mm cavity space. Ceramic Disc.

Chrome	SDCDUAL02	£757
Vintage Gold	SDCDUAL05	£890
Brushed Nickel	SDCDUAL12	£775

If you like this valve but want to choose different accessories, use the below code and see our kits on p148.

Chrome	SDCO4	£496
--------	-------	------

### Recessed Shower with Premium Fixed Head and Flexible Kit

Large 6" shower rose. Premium handset. Valve will fit in a 35mm cavity space. Hose outlet included. Ceramic Disc.

Chrome	SDCDUAL03	£921
Vintage Gold	SDCDUAL06	£1030
Brushed Nickel	SDCDUAL13	£945

If you like this valve but want to choose different accessories, use the below code and see our kits on p148.

Chrome	SDCO5	£649
--------	-------	------



# Dawlish Showers



## Exposed Shower with Premium Flexible Riser Kit

Premium handset.

Chrome	SDCDUAL09	£649
Vintage Gold	SDCDUAL10	£757
Brushed Nickel	SDCDUAL14	£665

*If you like this valve but want to choose different accessories, use the below code and see our kits on p148.*

Chrome	SDCB06	£555
Vintage Gold	SDAB06	£623

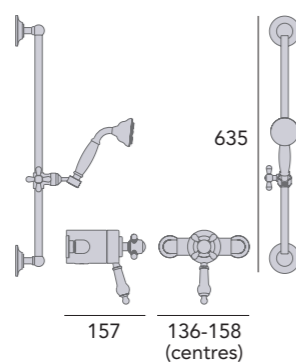

## Exposed Shower with Premium Fixed Riser Kit & Diverter to Handset

Large 6" shower rose. Premium handset.

Chrome	SDCDUAL07	£1207
Vintage Gold	SDCDUAL08	£1366
Brushed Nickel	SDCDUAL15	£1235

*If you like this valve but want to choose different accessories, use the below code and see our kits on p148.*

Chrome	SDCT06	£547
Vintage Gold	SDAT06	£623

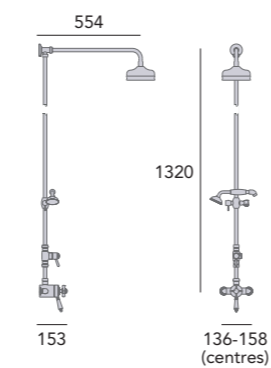

⊖ ⊕ ⊖ ⊕ ⊖ ⊕ ⊖ ⊕ ⊖ ⊕

THERMOSTATIC 1 OUTLET AVAILABLE IN CHROME AVAILABLE IN VINTAGE GOLD AVAILABLE IN BRUSHED NICKEL PERFORMANCE FLOW

Working pressure range: Min: 0.2 Max: 5.0

⊖ ⊕ 2 ⊖ ⊕ ⊖ ⊕ ⊖ ⊕ ⊖ ⊕

THERMOSTATIC 2 OUTLETS AVAILABLE IN CHROME AVAILABLE IN VINTAGE GOLD AVAILABLE IN BRUSHED NICKEL PERFORMANCE FLOW

Working pressure range: Min: 0.2 Max: 5.0

# Dawlish Shower Valves



## Exposed Shower Valve with Bottom Outlet Connection

Chrome	SDCB06	£555
Vintage Gold	SDAB06	£623

⊖ ⊕ C VG P

THERMOSTATIC AVAILABLE IN CHROME AVAILABLE IN VINTAGE GOLD PERFORMANCE FLOW

## Exposed Shower Valve with Top Outlet Connection

Chrome	SDCT06	£547
Vintage Gold	SDAT06	£623

⊖ ⊕ C VG P

THERMOSTATIC AVAILABLE IN CHROME AVAILABLE IN VINTAGE GOLD PERFORMANCE FLOW

## Dawlish Recessed Shower Valve Only

Chrome	SDC04	£496
--------	-------	------

*Concealed valve. Suitable for use with either a flexible kit or fixed head.*

⊖ ⊕ I C P

THERMOSTATIC 1 OUTLET AVAILABLE IN CHROME PERFORMANCE FLOW



## Dawlish Recessed Thermostatic Shower Valve with Twin Stopcocks

Chrome	SDC05	£649
--------	-------	------

*Concealed valve with integral twin stopcocks which allows simultaneous use with both a fixed head and flexible kit.*

⊖ ⊕ 2 C P

THERMOSTATIC 2 OUTLETS AVAILABLE IN CHROME PERFORMANCE FLOW

# Glastonbury Taps



### 3 Taphole Swivel Spout Basin Mixer

Spout Projection 160mm  
Full height 165mm  
Min. operating pressure 0.4bar  
Valve: Quarter turn ceramic disc

Chrome with White handle	TGRC09	£469
Vintage Gold with White handle	TGRG09	£577
Chrome with Midnight Blue handle	TGRBL09	£546
Brushed Nickel with White handle	TGRCN09	£445

Spout swivels left to right. Includes pop-up waste.



### 3 Taphole Basin Mixer

Spout Projection 95mm  
Full height 105mm  
Min. operating pressure 0.3bar  
Valve: Quarter turn ceramic disc

Chrome with White handle	TGRC06	£405
Vintage Gold with White handle	TGRG06	£476
Chrome with Midnight Blue handle	TGRBL06	£483
Brushed Nickel with White handle	TGRCN06	£449

Includes pop-up waste.



### Basin Pillar Taps

Spout Projection 90mm  
Full height 135mm  
Min. operating pressure 0.1bar  
Valve: Quarter turn ceramic disc

Chrome with White handle	TGRC00	£155
Vintage Gold with White handle	TGRG00	£188
Chrome with Midnight Blue handle	TGRBL00	£174
Brushed Nickel with White handle	TGRCN00	£175

Taps with longer spouts are ideal for use with inset basins.



### 1 Taphole Basin Mixer

Spout Projection 110mm  
Full height 139mm  
Min. operating pressure 0.4bar  
Valve: Quarter turn ceramic disc

Chrome with White handle	TGRC04	£289
Vintage Gold with White handle	TGRG04	£334
Chrome with Midnight Blue handle	TGRBL04	£329
Brushed Nickel with White handle	TGRCN04	£315

Includes pop-up waste.



### Bath Filler

Spout Projection 140mm  
Full height 145mm  
Min. operating pressure 0.1bar  
Valve: Quarter turn ceramic disc

Chrome with White handle	TGRC07	£399
Vintage Gold with White handle	TGRG07	£476
Chrome with Midnight Blue handle	TGRBL07	£476
Brushed Nickel with White handle	TGRCN07	£449

Deck mounted. Can be used with standpipes or shrouds on a freestanding bath. See p155.



### Bath Pillar Taps

Spout Projection 125mm  
Full height 145mm  
Min. operating pressure 0.1bar  
Valve: Quarter turn ceramic disc

Chrome with White handle	TGRC01	£188
Vintage Gold with White handle	TGRG01	£219
Chrome with Midnight Blue handle	TGRBL01	£200
Brushed Nickel with White handle	TGRCN01	£205

Deck mounted. Can be used with standpipes or shrouds on a freestanding bath. See p155.



### Bath Shower Mixer

Spout Projection 140mm  
Full height 307mm  
Min. operating pressure 0.2bar  
Valve: Quarter turn ceramic disc

Chrome with White handle	TGRC02	£514
Vintage Gold with White handle	TGRG02	£577
Chrome with Midnight Blue handle	TGRBL02	£577
Brushed Nickel with White handle	TGRCN02	£545

Deck mounted. Can be used with standpipes or shrouds on a freestanding bath. See p155.

# Glastonbury Showers

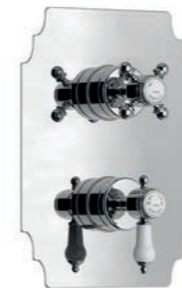

### Recessed Shower with Premium Fixed Head Kit

Large 6" shower rose. Valve will fit in a 35mm cavity space. Ceramic disc.

Chrome with White handle	SGDUAL01	£751
Vintage Gold with White handle	SGDUAL02	£885
Brushed Nickel	SGDUAL05	£769

If you like this valve but want to choose different accessories, use the below code and see our kits on p148.

Chrome	SGC03	£510
--------	-------	------

THERMOSTATIC  
 1 OUTLET  
 AVAILABLE IN CHROME  
 AVAILABLE IN VINTAGE GOLD  
 AVAILABLE IN BRUSHED NICKEL  
 PERFORMANCE FLOW

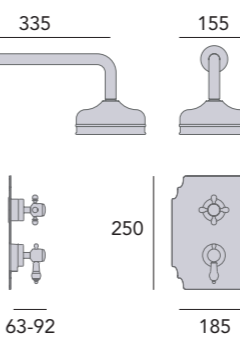

Working pressure range:  
Min: 0.2 Max: 5.0



### Recessed Shower with Premium Fixed Head and Flexible Riser Kit

Large 6" shower rose. Premium handset. Valve will fit in a 35mm cavity space. Hose outlet included. Ceramic disc.

Chrome	SGDUAL03	£885
Vintage Gold	SGDUAL04	£1035
Brushed Nickel	SGDUAL06	£905

If you like this valve but want to choose different accessories, use the below code and see our kits on p148.

Chrome	SGC04	£649
--------	-------	------

THERMOSTATIC  
 2 OUTLETS  
 AVAILABLE IN CHROME  
 AVAILABLE IN VINTAGE GOLD  
 AVAILABLE IN BRUSHED NICKEL  
 PERFORMANCE FLOW

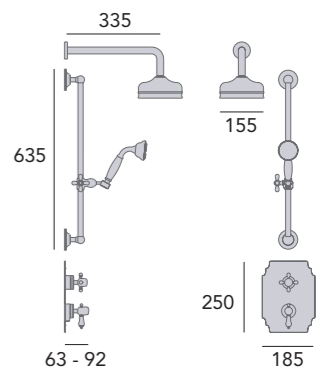

Working pressure range:  
Min: 0.2 Max: 5.0

# Glastonbury Showers



## Exposed Shower with Premium Flexible Riser Kit

Premium handset.

Chrome	SGSIN05	£604
Vintage Gold	SGSIN06	£668
Brushed Nickel	SGSIN07	£619

If you like this valve but want to choose different accessories, use the below code and see our kits on p148.

Chrome	SGCB03	£484
Vintage Gold	SGAB03	£565

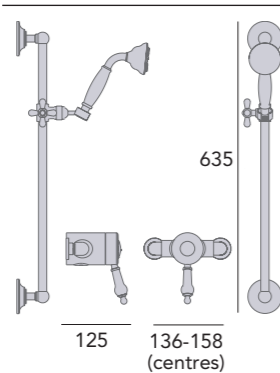

## Exposed Shower with Premium Fixed Riser Kit

Large 6" shower rose.

Chrome with White handle	SGSIN03	£783
Vintage Gold with White handle	SGSIN04	£921
Brushed Nickel	SGSIN08	£799

If you like this valve but want to choose different accessories, use the below code and see our kits on p148.

Chrome	SGCT03	£484
Vintage Gold	SGAT03	£567

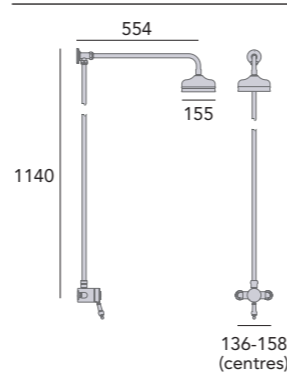

THERMOSTATIC
 1 OUTLET
 PERFORMANCE FLOW
 AVAILABLE IN CHROME
 AVAILABLE IN VINTAGE GOLD
 AVAILABLE IN BRUSHED NICKEL

Working pressure range:  
Min: 0.2 Max: 5.0

THERMOSTATIC
 1 OUTLET
 PERFORMANCE FLOW
 AVAILABLE IN CHROME
 AVAILABLE IN VINTAGE GOLD
 AVAILABLE IN BRUSHED NICKEL

Working pressure range:  
Min: 0.2 Max: 5.0

# Glastonbury Shower Valves



## Glastonbury Recessed Shower Valve Only

Chrome	SGC03	£510
--------	-------	------

THERMOSTATIC
 1 OUTLET
 AVAILABLE IN CHROME
 PERFORMANCE FLOW

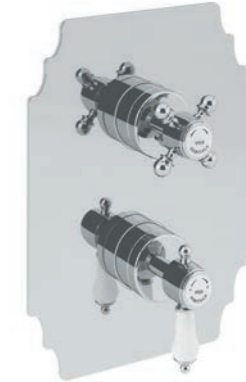

## Glastonbury Recessed Shower Valve with Diverter

Chrome	SGC04	£649
--------	-------	------

Valve will fit in a 35mm cavity space. Hose outlet included. Ceramic Disc.

THERMOSTATIC
 2 OUTLETS
 AVAILABLE IN CHROME
 PERFORMANCE FLOW



## Exposed Shower Valve with Bottom Outlet Connection

Chrome	SGCB03	£484
Vintage Gold	SGAB03	£565

THERMOSTATIC
 AVAILABLE IN CHROME
 AVAILABLE IN VINTAGE GOLD
 PERFORMANCE FLOW



## Exposed Shower Valve with Top Outlet Connection

Chrome	SGCT03	£484
Vintage Gold	SGAT03	£567

THERMOSTATIC
 AVAILABLE IN CHROME
 AVAILABLE IN VINTAGE GOLD
 PERFORMANCE FLOW

## Hartlebury Taps



### 3 Taphole Swivel Spout Basin Mixer

Spout Projection 180mm  
Full height 160mm  
Min. operating pressure 0.4bar  
Valve: Quarter turn ceramic disc

Chrome THRC09 **£508**  
Vintage Gold THRG09 **£610**

*Spout swivels left to right. Includes pop-up waste.*

### 3 Taphole Basin Mixer

Spout Projection 85mm  
Full height 110mm  
Min. operating pressure 0.3bar  
Valve: Quarter turn ceramic disc

Chrome THRC06 **£412**  
Vintage Gold THRG06 **£533**

*Includes pop-up waste.*

### Basin Pillar Taps

Spout Projection 85mm  
Full height 140mm  
Min. operating pressure 0.1bar  
Valve: Quarter turn ceramic disc

Chrome THRC00 **£181**  
Vintage Gold THRG00 **£225**

*Taps with longer spouts like this are ideal for use with no taphole inset basins.*

### 1 Taphole Basin Mixer

Spout Projection 140mm  
Full height 105mm  
Min. operating pressure 0.4bar  
Valve: Quarter turn ceramic disc

Chrome THRC04 **£289**  
Vintage Gold THRG04 **£387**

*Includes pop-up waste.*



### Bath Filler

Spout Projection 150mm  
Full height 150mm  
Min. operating pressure 0.2bar  
Valve: Quarter turn ceramic disc

Chrome THRC07 **£438**  
Vintage Gold THRG07 **£546**

*Deck mounted. Can also be used with standpipes for use with freestanding baths.*

### Bath Pillar Taps

Spout Projection 105mm  
Full height 170mm  
Min. operating pressure 0.2bar  
Valve: Quarter turn ceramic disc

Chrome THRC01 **£207**  
Vintage Gold THRG01 **£270**

### Deck Bath Shower Mixer

Spout Projection 155mm  
Full height 315mm  
Min. operating pressure 0.2bar  
Valve: Quarter turn ceramic disc

Chrome THRC02 **£577**  
Vintage Gold THRG02 **£707**

*Deck mounted. Can also be used with standpipes for use with freestanding baths.*



## Hartlebury Showers



### Recessed Shower with Premium Fixed Head Kit

Large 6" shower rose. Valve will fit in a 35mm cavity space. Ceramic disc.  
Chrome SHDDUAL03 **£757**

*Large 6" shower rose. Valve will fit in a 35mm cavity space. Ceramic disc.*

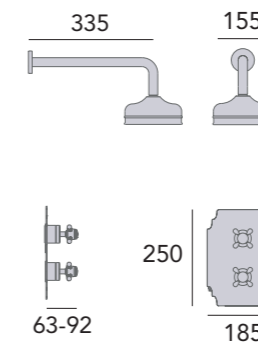

⊖ ⊕ THERMOSTATIC  
I 1 OUTLET  
C AVAILABLE IN CHROME  
P PERFORMANCE FLOW

Working pressure range:  
Min: 0.2 Max: 5.0

### Recessed Shower with Premium Fixed Head and Flexible Riser Kit

Large 6" shower rose. Premium handset. Valve will fit in a 35mm cavity space. Hose outlet included. Ceramic disc.

Chrome SHDDUAL05 **£885**  
Vintage Gold SHDDUAL06 **£1030**

*If you like this valve but want to choose different accessories, use the below code and see our kits on p148.*

Chrome SHDC03 **£649**

⊖ ⊕ THERMOSTATIC  
2 2 OUTLETS  
C AVAILABLE IN CHROME  
VG AVAILABLE IN VINTAGE GOLD  
P PERFORMANCE FLOW

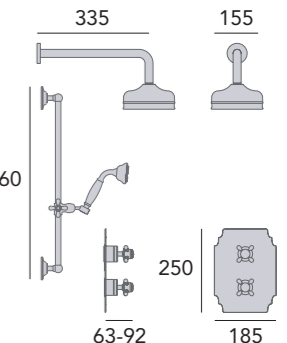

Working pressure range:  
Min: 0.2 Max: 5.0

# Hartlebury Showers

# Hartlebury Shower Valves



## Exposed Shower with Premium Flexible Riser Kit

Premium handset.  
 Chrome SHDDUAL09 £649  
 Vintage Gold SHDDUAL10 £751

*If you like this valve but want to choose different accessories, use the below code and see our kits on p148.*

Chrome SHDCB02 £541  
 Vintage Gold SHDAB02 £612

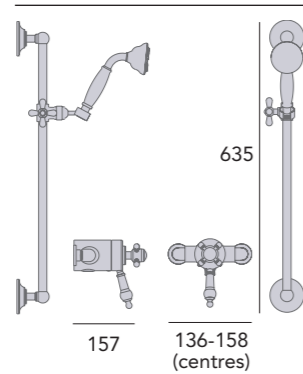

## Exposed Shower with Premium Fixed Riser Kit

Large 6" shower rose.  
 Chrome SHDDUAL07 £921  
 Vintage Gold SHDDUAL08 £1067

*If you like this valve but want to choose different accessories, use the below code and see our kits on p148.*

Chrome SHDCT02 £541  
 Vintage Gold SHDAT02 £612



THERMOSTATIC  
 1 OUTLET  
 AVAILABLE IN CHROME  
 AVAILABLE IN VINTAGE GOLD  
 PERFORMANCE FLOW

Working pressure range:  
 Min: 0.2 Max: 5.0

THERMOSTATIC  
 1 OUTLET  
 AVAILABLE IN CHROME  
 AVAILABLE IN VINTAGE GOLD  
 PERFORMANCE FLOW

Working pressure range:  
 Min: 0.2 Max: 5.0

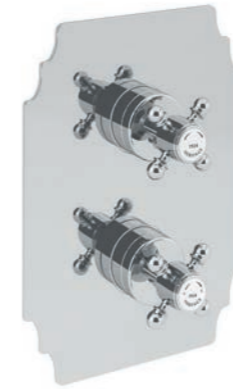

## Hartlebury Recessed Shower Valve with Diverter

Chrome SHDC03 £649

*Valve will fit in a 35mm cavity space. Hose outlet included. Ceramic Disc.*

THERMOSTATIC  
 1 OUTLET  
 AVAILABLE IN CHROME  
 PERFORMANCE FLOW



## Exposed Shower Valve with Bottom Outlet Connection

Chrome SHDCB02 £541  
 Vintage Gold SHDAB02 £612

THERMOSTATIC  
 AVAILABLE IN CHROME  
 AVAILABLE IN VINTAGE GOLD  
 PERFORMANCE FLOW



## Exposed Shower Valve with Top Outlet Connection

Chrome SHDCT02 £541  
 Vintage Gold SHDAT02 £612

THERMOSTATIC  
 AVAILABLE IN CHROME  
 AVAILABLE IN VINTAGE GOLD  
 PERFORMANCE FLOW

## Salcombe Basin Taps



### Basin Pillar Taps

Spout Projection 100mm  
Full height 146mm  
Min. operating pressure 0.5bar  
Valve: Quarter turn ceramic disc

Chrome	TSACC00	£175
Brushed Brass	TSACBB00	£199
Matt Black	TSACBL00	£199

### 1 Taphole Basin Mixer

Spout Projection 114mm  
Full height 312mm  
Min. operating pressure 0.5bar  
Valve: Quarter turn ceramic disc

Chrome	TSACC04	£225
Brushed Brass	TSACBB04	£269
Matt Black	TSACBL04	£269

### 3 Taphole Basin Mixer

Spout Projection 57mm  
Full height 235mm  
Min. operating pressure 0.5bar  
Valve: Quarter turn ceramic disc

Chrome	TSACC06	£325
Brushed Brass	TSACBB06	£399
Matt Black	TSACBL06	£399

## Salcombe Bath Taps



### Bath Filler

Spout Projection 115mm  
Full height 243mm  
Min. operating pressure 0.2bar  
Valve: Quarter turn ceramic disc

Chrome	TSACC07	£409
Brushed Brass	TSACBB07	£425
Matt Black	TSACBL07	£425

### Bath Pillar Taps

Spout Projection 100mm  
Full height 150mm  
Min. operating pressure 0.2bar  
Valve: Quarter turn ceramic disc

Chrome	TSACC01	£199
Brushed Brass	TSACBB01	£225
Matt Black	TSACBL01	£225

### Bath Shower Mixer

Spout Projection 114mm  
Full height 243mm  
Min. operating pressure 0.5bar  
Valve: Quarter turn ceramic disc

Chrome	TSACC02	£475
Brushed Brass	TSACBB02	£549
Matt Black	TSACBL02	£549



### 3 Taphole Wall Mounted Basin Mixer

Spout Projection 179mm  
Full height 78mm  
Min. operating pressure 0.5bar  
Valve: Quarter turn ceramic disc

Chrome	TSACC10	£325
Brushed Brass	TSACBB10	£419
Matt Black	TSACBL10	£419



### Tall Basin Mixer

Spout Projection 114mm  
Full height 452mm  
Min. operating pressure 0.5bar  
Valve: Quarter turn ceramic disc

Chrome	TSACCT04	£279
Brushed Brass	TSACBBT04	£325
Matt Black	TSACBLT04	£325



### Floor Standing Bath Shower Mixer

Spout Projection 200mm  
Full height 1128mm  
Min. operating pressure 0.5bar  
Valve: Quarter turn ceramic disc

Chrome	TSACC171	£985
Brushed Brass	TSACBB171	£1095
Matt Black	TSACBL171	£1095





## Salcombe Showers



Working pressure range: Min. 0.2, Max. 5.0 Bar

Working pressure range: Min. 0.2, Max. 5.0 Bar

Working pressure range: Min. 0.2, Max. 5.0 Bar

### Salcombe Concealed Shower with Fixed Head and Flexible Kit

### Salcombe Concealed Shower with Fixed Head and Flexible Kit

### Salcombe Concealed Shower with Fixed Head and Flexible Kit

Chrome SSACDUAL01 £799

Brushed Brass SSACDUAL02 £919

Matt Black SSACDUAL03 £919



## Salcombe Shower Valves



### 1 Outlet 2 Handle Concealed Thermostatic Valve

Chrome	SSAC01	£380
Brushed Brass	SSABB01	£439
Matt Black	SSABLO1	£439



## Trinity Basin Taps



### Basin Pillar Taps

Spout Projection 100mm  
Full height 135mm  
Min. operating pressure 0.2bar  
Valve: Quarter turn ceramic disc

Chrome TTRCC00 **£199**

### Bath Pillar Taps

Spout Projection 105mm  
Full height 145mm  
Min. operating pressure 0.2bar  
Valve: Quarter turn ceramic disc

Chrome TTRCC01 **£220**

### 1 Taphole Basin Mixer

Spout Projection 135mm  
Full height 120mm  
Min. operating pressure 0.2bar  
Valve: Quarter turn ceramic disc

Chrome TTRCC04 **£225**

*Pop-up waste included.*

## Trinity Bath Taps



### Bath Shower Mixer

Spout Projection 150mm  
Full height 300mm  
Min. operating pressure 0.2bar  
Valve: Quarter turn ceramic disc

Chrome TTRCC02 **£365**

### Bath Filler

Spout Projection 149mm  
Full height 140mm  
Min. operating pressure 0.2bar  
Valve: Quarter turn ceramic disc

Chrome TTRCC07 **£310**

### 3 Taphole Bath Filler

Spout Projection 175mm  
Full height 135mm  
Min. operating pressure 0.2bar  
Valve: Quarter turn ceramic disc

Chrome TTRCC073 **£377**



### 3 Taphole Basin Mixer

Spout Projection 125mm  
Full height 125mm  
Min. operating pressure 0.2bar  
Valve: Quarter turn ceramic disc

Chrome TTRCC06 **£329**

*Pop-up waste included.*



## Trinity Showers

### Recessed Shower with Premium Fixed Head and Flexible Riser Kit

Extra large 8" shower rose  
 Premium handset  
 Valve will fit in a 35mm cavity space  
 Hose outlet included  
 Ceramic disc  
 Chrome STRCDUAL01 **£585**

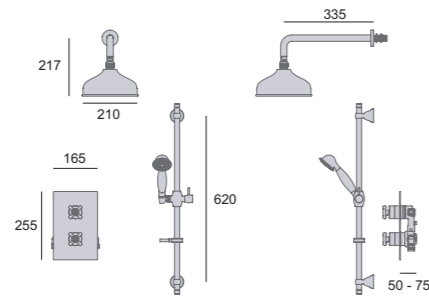

Working pressure range: Min. 0.2, Max. 5.0 Bar



## Trinity Showers

### Exposed Shower with Premium Fixed Riser Kit & Diverter to Handset

Extra large 8" shower rose  
 Premium handset  
 Chrome STRCDUAL02 **£1150**

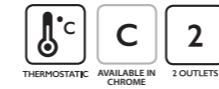
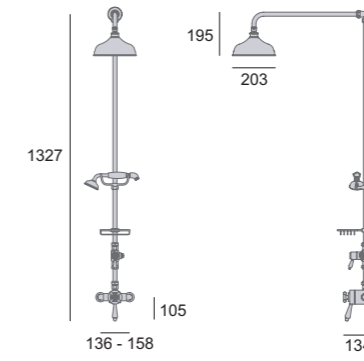

Working pressure range: Min. 0.2, Max. 5.0 Bar



# Shower Accessories

Our range of stylish shower accessories are the perfect way to reinvigorate an existing shower, or create a bespoke look by combining them with our valve only options.

Use the quick guide below to help choose the right shower accessory for your valve.

## Valve - Type

	Flexible Riser only	Fixed Head only	Both	Fixed Head with a Diverter & Flexible Riser
1 outlet recessed valve	✓	✓		
2 outlet recessed valve			✓	
Bottom outlet exposed valve	✓			
Top outlet exposed valve		✓		✓



## Shower Accessories



### Premium Fixed Head

Chrome STC19 £363  
Vintage Gold STA19 £396

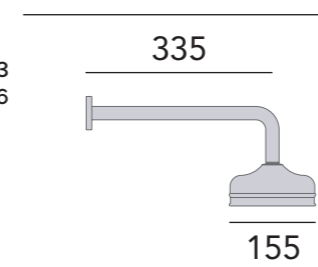

Large 6" shower head.



### Shower Head 200mm

Chrome STC22 £100  
Brushed Brass STBB22 £130  
Matt Black STBL22 £130

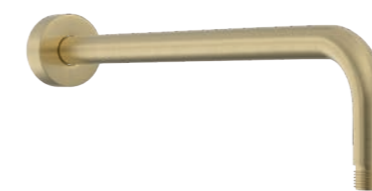
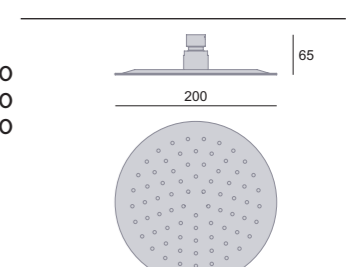

### Wall Mounted Shower Arm

Chrome STC24 £75  
Brushed Brass STBB24 £89  
Matt Black STBL24 £89

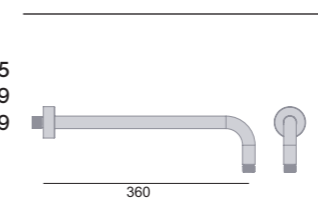

## Shower Accessories

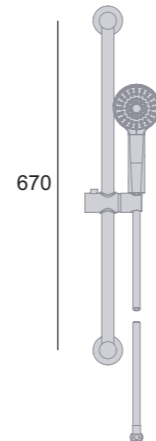
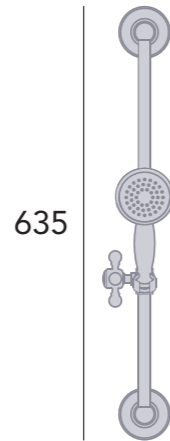
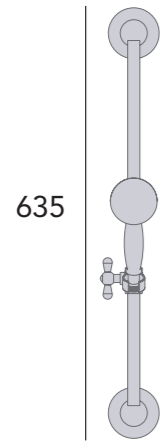

**Premium Adjustable Riser Kit with Handset**

Chrome STC08  
Vintage Gold STA08

**Adjustable Riser Kit with Handset**

£212 Chrome STC04  
£268 Vintage Gold STA04

**Adjustable Riser Kit with Multi-Function Handset & Wall Outlet**

£161 Chrome STC23  
£217 Brushed Brass STBB23  
Matt Black STBL23 £259  
£299  
£299



## Shower Accessories

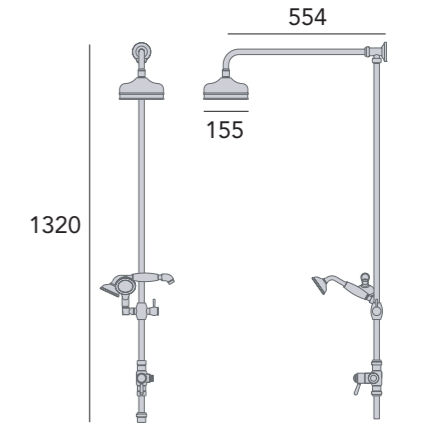
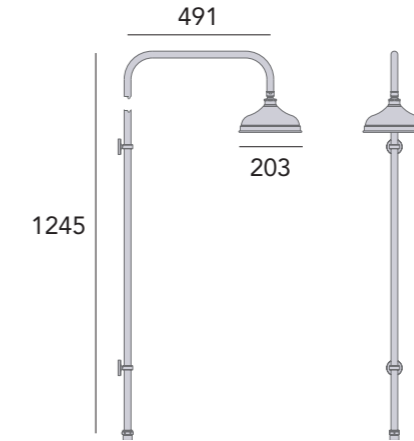
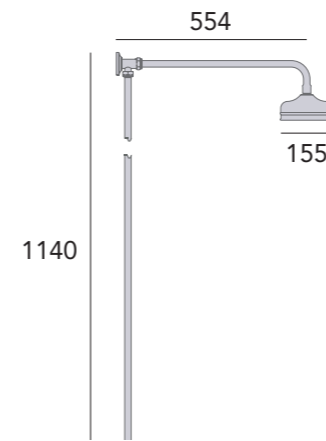

**Fixed Riser Kit with Head**

Chrome STC16 £376  
Vintage Gold STA16 £484

**Deluxe Fixed Riser Kit with Head**

Chrome STC17 £459

**Fixed Riser Kit with Diverter to Head and Handset**

Chrome STC15 £484  
Vintage Gold STA15 £630



Large 6" shower head.



Extra large 8" shower head.



Large 6" shower head.

## Wastes & Extras



### Basin Waste

Chrome	THC10	£22
Vintage Gold	THA10	£37
Brushed Nickel	THBN10	£35

### Ornate Basin Waste

Chrome	THC10P	£37
Vintage Gold	THA10P	£52

Porcelain plug.

### Bath Waste

Chrome	THC11	£30
Vintage Gold	THA11	£42
Brushed Nickel	THBN11	£39

## Wastes & Extras



### Bath Pop Up Waste

Chrome	THC14	£42
Vintage Gold	THA14	£63
Brushed Nickel	THBN14	£59
Brushed Brass	THBB14	£59
Matt Black	THBL14	£59

Not suitable for use with freestanding baths.

### Exposed Push Button Bath Waste and Overflow Kit

Chrome	THC21	£245
Brushed Nickel	THBN21	£250
Brushed Brass	THBB21	£250
Matt Black	THBL21	£250

Decorative overflow and waste kit for use with freestanding baths. Includes overflow cover and push button bath waste.

### Push Button Bath Waste

Chrome	THC22	£77
Vintage Gold	THA22	£85
Brushed Nickel	THBN22	£79
Brushed Brass	THBB22	£79
Matt Black	THBL22	£79

Easy to operate push button bath waste and overflow cover.



### Ornate Bath Waste

Chrome	THC11P	£42
Vintage Gold	THA11P	£59

Porcelain plug.

### Clicker Basin Waste Slotted

Chrome	THC12	£42
Vintage Gold	THA12	£59
Brushed Nickel	THBN12	£55
Brushed Brass	THBB12	£55
Matt Black	THBL12	£55

Slotted for use with basins that have a built in overflow.

### Clicker Basin Waste Unslotted

Chrome	THC12UN	£42
Vintage Gold	THA12UN	£55
Brushed Nickel	THBN12UN	£55
Brushed Brass	THBB12UN	£55
Matt Black	THBL12UN	£55

Unslotted for use with basins that do not have a built in overflow.



### Traditional Bottle Trap

Chrome	THC19	£52
Vintage Gold	THA19	£73
Brushed Nickel	THBN19	£69

Decorative waste for use with wall mounted basins.

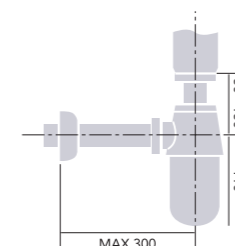

### Bottle Trap

Chrome	TSC19	£63
Vintage Gold	TSA19	£85
Brushed Nickel	TSBN19	£85

Decorative waste for use with wall mounted basins.

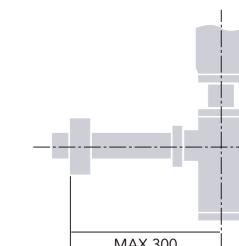

## Wastes & Extras



### Handset

Chrome	THC24	£63
Vintage Gold	THA24	£72

### 5ft Hose

Chrome	THC25	£30
Vintage Gold	THA25	£37

### Wall Bracket

Chrome	THC18	£22
Vintage Gold	THA18	£39

*Hands-Free Kit for shower handsets.*

## Wastes & Extras



### Standpipes

Chrome	THC20	£469
Vintage Gold	THA20	£578
Brushed Nickel	THBN20	£318

*Decorative pipework designed to support taps or mixers near freestanding baths and conceal the water pipes fed from under the floor. Standpipes can be cut down to size to fit your chosen bath. Use with baths without tapholes. Height 670mm. Use with taps that have separate legs.*

### Shrouds

Chrome	THC30	£289
Vintage Gold	THA30	£386
Brushed Nickel	THBN30	£516

*Decorative pipework to conceal water pipes fed from under the floor to the bath mounted taps and mixers. Shrouds can be cut down to size to fit your chosen bath. Use with baths with tapholes. Height 600mm.*



### Ornate Brackets

Chrome	CPC30	£110
Vintage Gold	CPA30	£143

### Overflow Cover

Black	THB1OF	£15
Brushed Brass	THBB1OF	£15

*Decorative brackets for use with cloakroom and corner basins where appropriate. Note: Basins must be fixed securely to the wall and should not rely on these brackets for support.*



### Exposed Bath Waste & Overflow

Chrome	THC16	£129
Vintage Gold	THA16	£181
Brushed Nickel	THBN16	£169
Chrome	THC16P	£143
Vintage Gold	THA16P	£181

*Decorative overflow and waste kit for use with freestanding baths. 'P' suffix codes include a porcelain plug.*

### Exposed Shallow Bath Trap

Chrome	THC15CI	£116
Vintage Gold	THA15CI	£143
Brushed Nickel	THBN15CI	£135

*Decorative waste pipe and trap to use instead of plastic pipe beneath freestanding baths.*

# Mirrors



Our range includes the timeless Arched option, as well as stylish new illuminated mirrors.

Available in a selection of finishes including classic Chrome, bold Black and Vintage Gold, you can combine gorgeous style with practical features, like heated demister pads and dual lighting options: cool white task lighting or warm white mood lighting.





## Illuminated Mirrors

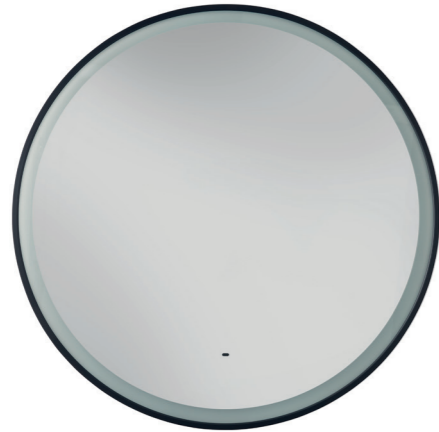

### Newick Illuminated Mirror 590mm

Height 590mm  
Width 590mm  
Depth 31mm

Chrome	MNEC590	£309
Black	MNEBL590	£355

*IP44 Rated for safe use above a basin. Heated demister pad.  
Touchless on/off. Change between cool white task lighting and warm white mood lighting.*

## Illuminated Mirrors



### Amberley Illuminated Circular Mirror 590mm

Height 950mm  
Width 590mm  
Depth 31mm

Chrome	MAMC590	£340
Black	MAMBL590	£390

*IP44 Rated for safe use above a basin. Heated demister pad.  
Touchless on/off. Change between cool white task lighting and warm white mood lighting.*

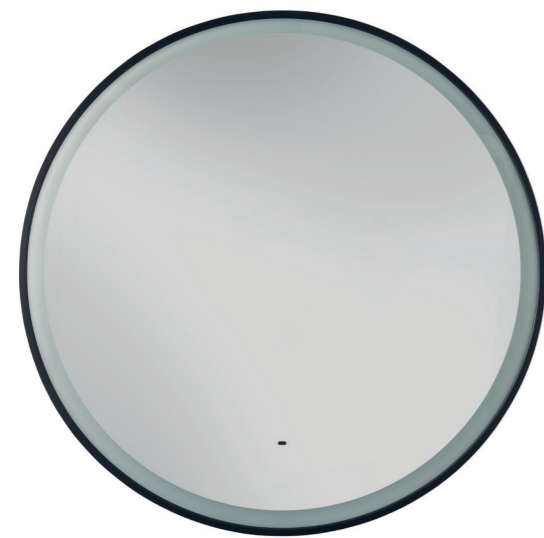

### Newick Illuminated Mirror 800mm

Height 800mm  
Width 800mm  
Depth 31mm

Chrome	MNEC800	£375
Black	MNEBL800	£429

*IP44 Rated for safe use above a basin. Heated demister pad.  
Touchless on/off. Change between cool white task lighting and warm white mood lighting.*

### Amberley Illuminated Circular Mirror 800mm

Height 1110mm  
Width 800mm  
Depth 31mm

Chrome	MAMC800	£399
Black	MAMBL800	£459

*IP44 Rated for safe use above a basin. Heated demister pad.  
Touchless on/off. Change between cool white task lighting and warm white mood lighting.*



## Illuminated Mirrors



### Kingston Illuminated Mirror 400mm

Height 800mm  
Width 400mm  
Depth 31mm

Chrome	MKIC4080	<b>£345</b>
Vintage Gold	MKIG4080	<b>£399</b>
Black	MKIBL4080	<b>£399</b>

*IP44 Rated for safe use above a basin. Heated demister pad. Touchless on/off. Change between cool white task lighting and warm white mood lighting.*

## Illuminated & Standard Mirrors

### Stanmer Illuminate Mirror 600mm

Height 800mm  
Width 600mm  
Depth 27mm

MSTNF6080	<b>£350</b>
-----------	-------------

*IP44 Rated for safe use above a basin. Heated demister pad. Touchless on/off. Change between cool white task lighting and warm white mood lighting.*



### Kingston Illuminated Mirror 600mm

Height 800mm  
Width 600mm  
Depth 31mm

Chrome	MKIC6080	<b>£375</b>
Vintage Gold	MKIG6080	<b>£430</b>
Black	MKIBL6080	<b>£430</b>

*IP44 Rated for safe use above a basin. Heated demister pad. Touchless on/off. Change between cool white task lighting and warm white mood lighting.*

### Arched Mirror

Height 673mm  
Width 488mm  
Depth 25mm

Chrome	AHCO9	<b>£233</b>
--------	-------	-------------



# Accessories



The finishing touch, our bathroom accessories are designed to be luxurious and practical.

Created from high quality materials, our ranges have everything you'll need, including stylish shelves, toothbrush holders and towel rails.

Available in a choice of brilliant finishes, you can be sure that they look fabulous and are built to withstand the rigours of daily use too.



## Chancery



### Toilet Roll Holder

Height 145mm  
Width 150mm  
Depth 66mm

Chrome ACHTRHC £56



### Tumbler & Holder

Height 95mm  
Width 119mm  
Depth 90mm

Chrome ACHTUHC £65



### Double Tumbler & Holder

Height 95mm  
Width 195mm  
Depth 90mm

Chrome ACHDTHC £85

## Chancery



### Towel Ring

Height 200mm  
Width 185mm  
Depth 73mm

Chrome ACHTRGC £65



### Double Glass Shelf

Height 417mm  
Width 408mm  
Depth 135mm

Chrome ACHDGSC £175



### Single Glass Shelf

Height 55mm  
Width 450mm  
Depth 128mm

Chrome ACHSGSC £116



### Soap Dish

Height 55mm  
Width 140mm  
Depth 108mm

Chrome ACHSPDC £65



### Soap Dispenser

Height 178mm  
Width 119mm  
Depth 90mm

Chrome ACHSDIC £65



### Robe Hook

Height 53mm  
Width 50mm  
Depth 66mm

Chrome ACHRBHC £37



### Single Towel Rail

Height 50mm  
Width 590mm  
Depth 66mm

Chrome ACHSTRC £85



### Double Towel Rail

Height 50mm  
Width 590mm  
Depth 110mm

Chrome ACHDTRC £103

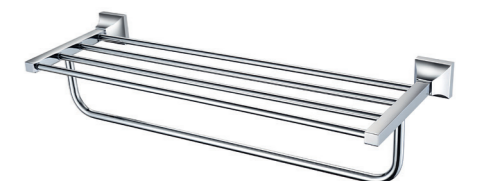

### Double Bathroom Towel Shelf

Height 135mm  
Width 590mm  
Depth 200mm

Chrome ACHDBTC £180

# Clifton



### Toilet Roll Holder

Height 95mm  
Width 185mm  
Depth 96mm

Chrome	ACC00	<b>£49</b>
Vintage Gold	ACA00	<b>£65</b>



### Tumbler & Holder

Height 102mm  
Width 82mm  
Depth 130mm

Chrome	ACC03	<b>£56</b>
Vintage Gold	ACA03	<b>£72</b>



### Toothbrush Holder

Height 66mm  
Width 83mm  
Depth 130mm

Chrome	ACC02	<b>£53</b>
--------	-------	------------

*Suitable for electric toothbrush heads*

# Clifton



### Towel Ring

Height 75mm  
Width 108mm  
Depth 126mm

Chrome	ACC01	<b>£53</b>
Vintage Gold	ACA01	<b>£65</b>



### Towel Rail

Height 65mm  
Width 680mm  
Depth 100mm

Chrome	ACC06	<b>£89</b>
Vintage Gold	ACA06	<b>£111</b>

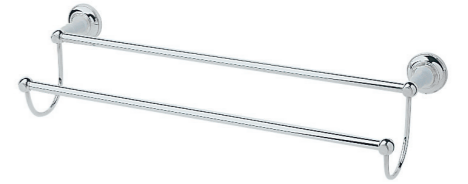

### Double Towel Rail

Height 155mm  
Width 680mm  
Depth 200mm

Chrome	ACC07	<b>£98</b>
Vintage Gold	ACA07	<b>£129</b>



### Soap Dish

Height 75mm  
Width 125mm  
Depth 147mm

Chrome	ACC04	<b>£56</b>
Vintage Gold	ACA04	<b>£65</b>



### Soap Basket

Height 66mm  
Width 120mm  
Depth 160mm

Chrome	ACC14	<b>£65</b>
Vintage Gold	ACA14	<b>£89</b>



### Robe Hook

Height 65mm  
Width 65mm  
Depth 76mm

Chrome	ACC10	<b>£37</b>
Vintage Gold	ACA10	<b>£42</b>

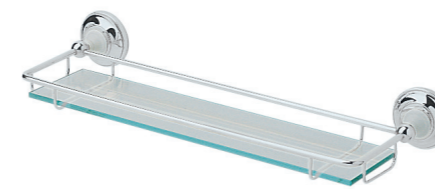

### Glass Shelf

Height 65mm  
Width 475mm  
Depth 155mm

Chrome	ACC08	<b>£117</b>
Vintage Gold	ACA08	<b>£168</b>

*Opaque safety glass shelf.*

# Holborn



### Toilet Roll Holder

Height 100mm  
Width 142mm  
Depth 73mm

Chrome	AHOTRHC	£56
Vintage Gold	AHOTRHG	£72



### Traditional Toilet Roll Holder

Height 45mm  
Width 195mm  
Depth 80mm

Chrome	AHOTTRC	£85
Vintage Gold	AHOTTRG	£98
Brushed Nickel	AHOTTRBN	£94



### Robe Hook

Height 80mm  
Width 50mm  
Depth 100mm

Chrome	AHORBHC	£37
Vintage Gold	AHORBHG	£42
Brushed Nickel	AHORBHBN	£41



### Tumbler & Holder

Height 95mm  
Width Single 125mm  
Depth 95mm

Chrome	AHOTUHC	£56
Vintage Gold	AHOTUHG	£72
Brushed Nickel	AHOTUHN	£62



### Tumblers & Holder

Height 95mm  
Width Double 205mm  
Depth 95mm

Chrome	AHODTHC	£85
Vintage Gold	AHODTHG	£98



### Soap Dish

Height 50mm  
Width 143mm  
Depth 113mm

Chrome	AHOSPDC	£65
Vintage Gold	AHOSPDG	£72



### Soap Dispenser

Height 178mm  
Width 125mm  
Depth 95mm

Chrome	AHOSDIC	£65
--------	---------	-----

# Holborn



### Towel Ring

Height 200mm  
Width 185mm  
Depth 73mm

Chrome	AHOTRGC	£65
Vintage Gold	AHOTRGG	£78
Brushed Nickel	AHOTRGN	£72



### 2 Tier Wire Basket

Height 325mm  
Width 200mm  
Depth 200mm

Chrome	ACOB03C	£143
--------	---------	------



### Double Glass Shelf

Height 425mm  
Width 410mm  
Depth 123mm

Chrome	AHODGSC	£168
--------	---------	------



### Single Glass Shelf

Height 78mm  
Width 550mm  
Depth 135mm

Chrome	AHOSGSC	£116
Vintage Gold	AHOSGSG	£130

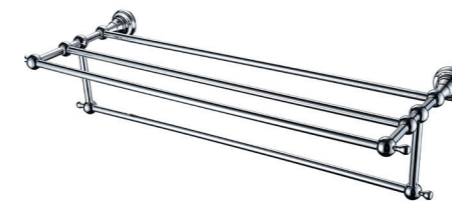

### Double Towel Shelf

Height 150mm  
Width 615mm  
Depth 230mm

Chrome	AHODBTC	£168
--------	---------	------



### Single Towel Rail

Height 50mm  
Width 615mm  
Depth 73mm

Chrome	AHOSTRC	£85
Vintage Gold	AHOSTRG	£98

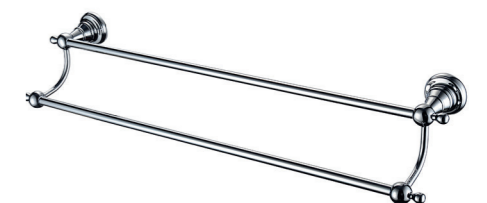

### Double Towel Rail

Height 100mm  
Width 615mm  
Depth 119mm

Chrome	AHODTRC	£98
--------	---------	-----

# Lullington



### Towel Rail

Height 48mm  
Width 595mm  
Depth 72mm

Chrome	ALUSTRC	£63
Matt Black	ALUSTRBL	£75
Brushed Brass	ALUSTRBB	£75

### Robe Hook

Height 55mm  
Width 48mm  
Depth 50mm

Chrome	ALURBHC	£26
Matt Black	ALURBHBL	£32
Brushed Brass	ALURBHBB	£32

### Towel Ring

Height 205mm  
Width 190mm  
Depth 60mm

Chrome	ALUTRGC	£38
Matt Black	ALUTRGBL	£45
Brushed Brass	ALUTRBB	£45



### Toilet Roll Holder

Height 105mm  
Width 148mm  
Depth 60mm

Chrome	ALUTRHC	£35
Matt Black	ALUTRHBL	£42
Brushed Brass	ALUTRHBB	£42

# Complimentary

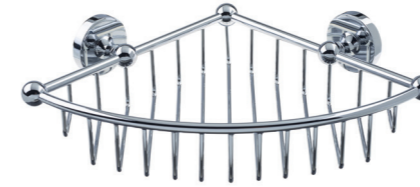

### Corner Wire Basket

Height 310mm  
Width 220mm  
Depth 50mm

Chrome	ACOB04C	£103
--------	---------	------



### Corner Wire Basket

Height 55mm  
Width 200mm  
Depth 200mm

Chrome	ACOB02C	£68
Vintage Gold	ACOB02G	£89



### Rectangle Wire Basket

Height 80mm  
Width 250mm  
Depth 120mm

Chrome	ACOB01C	£85
Vintage Gold	ACOB01G	£103



### Bath Rack

Height 50mm  
Width 210mm  
Depth 820mm

Chrome	ACOBHRC	£143
Vintage Gold	ACOBHRG	£206



### Shower Tidy

Height 435mm  
Width 165mm  
Depth 205mm

Chrome	ACOSHTC	£194
Vintage Gold	ACOSHTG	£226



### Round Toilet Brush

Height 390mm  
Width 90mm  
Depth 90mm

Chrome	ACOTBRRC	£56
--------	----------	-----



### Square Toilet Brush

Height 370mm  
Width 85mm  
Depth 85mm

Chrome	ACOTBRSC	£56
--------	----------	-----

# Heated Towel Rails



Practical and stylish, our beautiful towel rails are available in a wide range of sizes to suit every home, including the Baby Clifton, perfect for smaller bathrooms.

All of our heated towel rails are UKCA and CE compliant and rigorously tested to British Standards.

For ease of installation, all rails come complete with valves, as well as a five-year guarantee for absolute peace of mind.





## Heated Towel Rails



### Clifton

Height 940mm  
Width 734mm  
Valve centre 510mm  
Wall to valve centre 105mm  
Output 2340 Btu (686 watts)

Chrome, White Bars      AHC73      **£932**

*Includes valves in Chrome finish. Suitable for closed central heating systems only.*

### Baby Clifton

Height 940mm  
Width 498mm  
Valve centre 270mm  
Wall to valve centre 105mm  
Output 1335 Btu (391 watts)

Chrome, White Bars      AHC80      **£774**  
Chrome, Black Bars      AHC80B      **£788**  
Vintage Gold, White Bars      AHA80      **£1009**

*Includes valves in Chrome or Vintage Gold finish. Suitable for closed central heating systems only.*

### Clifton Wall Hung

Height 685 (exc. valves)mm  
Width 675mm  
Valve centre 600mm  
Wall to valve centre 55mm  
Output 1798 Btu (527 watts)

Chrome      AHC101      **£966**

*Wall mounted only. Includes valves. Suitable for closed central heating systems only.*

## Heated Towel Rails



### Cabot Wall Hung

Height 1355 (exc. Valves)mm  
Width 574mm  
Valve centre 500mm  
Wall to valve centre 55mm  
Output 2167 Btu (635 watts)

Chrome      AHC102      **£1109**

*Wall mounted only. Includes valves in Chrome. Suitable for closed central heating systems only.*

### Cabot

Height 1500mm  
Width 580mm  
Valve centre 350mm  
Wall to valve centre 105mm  
Output 2153 Btu (631 watts)

Chrome      AHC90      **£1074**

*Includes valves in Chrome. Suitable for closed central heating systems only.*



### Portland

Height 850mm  
Width 575mm  
Valve centre 350mm  
Wall to valve centre 110mm  
Output 529 Btu (155 watts)

Chrome      AHC76      **£610**  
Vintage Gold      AHA76      **£752**

*Includes valves in Chrome or Vintage Gold finish. Suitable for closed central heating systems only.*

### Portland Wall Mounted

Height 740mm  
Width 475mm  
Valve centre 400mm  
Wall to valve centre 80mm  
Output 475 Btu (139 watts)

Chrome      AHC94      **£539**

*Includes valves in Chrome. Wall mounted rail is ideal for use in cloakrooms and ensuites. Suitable for closed central heating systems only.*

## Heated Towel Rail Valves



### Valves

Chrome      AHC75      **£124**  
Vintage Gold      AHA75      **£140**

*All Heritage style heated towel rails include a pair of valves at no extra charge. They are also available to buy separately. Can be used for wall and floor plumbing connections.*

## Caring for your products

### CLEANING CAST IRON BATHS

**DO'S**

Do be careful not to drop anything in the bath as the enamel could chip.

DO rinse thoroughly with water and wipe down after each use.

**DON'TS**

Don't clean the outside with any chemicals that could remove the paint.

Dont drop anything in the bath.

### CLEANING ACRYLIC BATHS

**DO'S**

Do wipe over with a damp cloth regularly.

Do dry the area around the plughole.

Do take extra care with special finish baths.

**DON'TS**

Don't use abrasive chemicals as it may scratch the gloss finish.

### CLEANING TAPS, SHOWERS AND WASHSTANDS

**DO'S**

If limescale needs to be removed, do use a solution of 50% water, 50% white vinegar.

On special finishes do use a silver polish and tarnish guard for additional protection.

**DON'TS**

Don't use corrosive and abrasive cleaning products.

Don't use bleach.

### CLEANING TOILET SEATS

**DO'S**

Do clean regularly as build-up of deposits may cause damage.

**DON'TS**

Don't use corrosive cleaning products.

Don't use bleach.

### CLEANING SANITARYWARE

**DO'S**

Do regularly wipe down with a soft damp cloth.

**DON'TS**

Don't use any abrasive cleaning agents or materials such as bleach or scouring pads.

### FURNITURE CARE

**DO'S**

Do check the hinges and handles regularly to make sure they haven't become loose.

Wherever possible wipe down standing water immediately.

**DON'TS**

Don't use any abrasive cleaning products.

### MIRROR CARE

**DO'S**

Do use a soft cloth and glass cleaner on the glass.

Do use a dry soft cloth to remove dust from the frame.

**DON'TS**

Don't clean the mirror surface with anything abrasive.

Don't use any cleaning products on the mirror surround.

### HEATED TOWEL RAIL CARE

**DO'S**

Do dust regularly.

Do use a damp cloth.

**DON'TS**

Don't use abrasive or corrosive cleaning products as they may damage the paint finish.

### ACCESSORIES CARE

**DO'S**

Do avoid prolonged contact with water and dry after use.

**DON'TS**

Don't use abrasive or corrosive cleaning products.

## Explaining Water Efficiency

There are over 60 million people living in the UK, using on average 150 litres of water per day for washing, cooking and drinking. Improvements in lifestyle and new technologies within the domestic environment mean we use 55% more water than we did 25 years ago, with half of this being used within the bathroom environment.

As climate change takes a greater hold on the environment we understand it is essential for us all to use water wisely. At Heritage we appreciate how important it is to save water and that's why we have designed selected products to optimise water usage in the bathroom.

You can now tell how much water a product uses in normal domestic conditions by looking for the Water Label. A green indicator flag shows that a product uses the least amount of water whereas a red flag indicates that a product uses more water; however this gives you a greater flow from your taps and showers for a faster filling basin or bath and more invigorating shower.

You can find a complete explanation of the European Water Label and how it works at: [www.europeanwaterlabel.eu](http://www.europeanwaterlabel.eu)

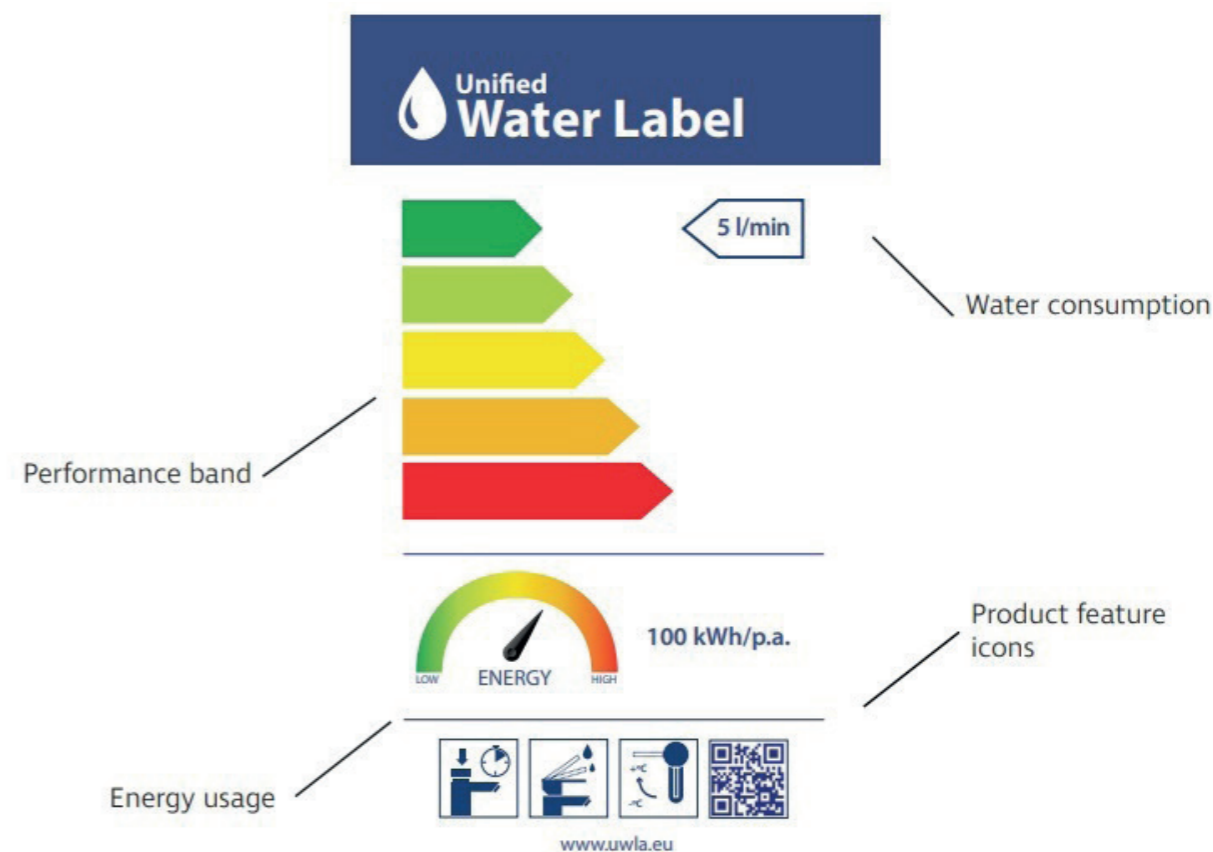

#### Taps & Showers Water Label guide



#### Baths Water Label guide

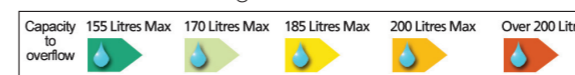

#### WCs Water Label guide

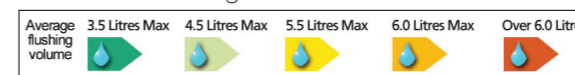

All flow rates are given at 3.0bar water pressure

## Useful Information

### BATHS

#### Acrylic baths

Reflectivity of materials may vary, in some light conditions the white may look a little different.

Heritage bath panels are designed to go with Heritage baths, a 1700mm panel for a 1700mm bath etc.

#### Cast iron baths

Cast iron baths are still made in the traditional way which includes a degree of surface ripple, dimples and minuscule black specks in the interior. This is all part of the character of a cast iron bath giving a feeling of uniqueness in your bathroom.

The exterior of our cast iron baths come smooth and pre-primed ready to paint. This isn't the finished article though and may suffer minor wear and tear en route to you. It will be instantly restored when you paint it in your chosen colour.

### BASINS, WCs & BIDETS

Each piece of sanitaryware is individually made which means dimensions given are always 'approximate' within standard industry tolerances. If precise measurements are required then you must measure the actual pieces when they are delivered and plan your bathroom around them.

Every effort is made to ensure our sanitaryware is straight and level, and our standards are significantly higher than those set out in the current British Standards. However, when used on furniture, for example, there will be situations where an inexact basin will meet a perfectly straight worktop and sealant will need to be applied to fill any inconsistencies, ensuring a stable fit and sealing the furniture from water ingress.

Due to manufacturing processes slight colour variation is possible in ceramic items.

This brochure supersedes all previous issues of the Heritage Collection with effect from the issue date shown until replaced by a new edition. Heritage holds intellectual property rights, including but not limited to unregistered design right, copyright, registered designs and patents in the United Kingdom, and other similar rights elsewhere to all the goods that are proprietary to us and their drawings, designs and specifications. Along with our stockists we will establish, prosecute and defend those rights. All rights reserved. No part of this work may be reproduced, utilised or stored in any form or by any means without written permission from Heritage Bathrooms. E&OE. Prices correct at time of print. At Heritage Bathrooms it is our policy to strive to continuously improve the quality of our goods, as a result our products will also be subject to changes in design, materials, components and finishes. All goods are subject to such variations in size, colour and finish and are within normally accepted manufacturing tolerances. Also, as products are subject to changes this may affect the qualification for various product approvals and so we will not be held responsible for any reliance placed on approval references within drawings, descriptive matter, price

The lifetime guarantee on sanitaryware extends to the ceramic pieces only. The cistern fittings are guaranteed for 5 years.

The inlets on our ceramic cisterns vary depending on the product. Please contact our customer service team for more information.

### HERITAGE LOGO

The word Heritage is used as a hallmark to denote a genuine Heritage product.

### TAPS & SHOWER VALVES

Heritage taps are designed to be compatible with Heritage sanitaryware and baths. A 1 tap hole basin mixer will be suitable for any 1 tap hole basin, the few exceptions to this rule will be highlighted in the directory section.

The majority of Heritage taps and shower valves have been engineered to operate on low pressure making them compatible with all UK plumbing systems. The minimum operating pressure for each tap and shower valve is stated in the directory for you to confirm compatibility with your installer.

#### Measuring tap spout projections

Spout projection measurements refer to the dimension from the centre of the body to the centre of the spout.

### BRASSWARE FINISHES

Chrome is an extremely durable plated finish which is applied to a variety of fittings in a consistent manner and features a 10 year guarantee. Special finishes, such as Vintage Gold are more delicate so when applied to high use fittings such as taps and showers, or a plated finish we use on shower kits, hoses and accessories, feature a 3 year guarantee only.

Close inspection may show some colour variation which is normally acceptable given the relative distance between individual fittings when installed.

lists, catalogues, brochures, websites, and other promotional material unless it has been directly confirmed by us in writing at the time the products are ordered.

#### Trade Mark and Data Protection

Our trade mark HERITAGE is registered in the United Kingdom and throughout Europe. You will not use our trade mark, or any of the range or product names or images of our products without approval.

**Heritage Bathrooms** is a member of the Bathroom Manufacturer's Association [www.bathroom-association.org](http://www.bathroom-association.org). ®Registered trademark of Heritage Bathrooms. Part of Bristan Group Limited. A MASCO company. [www.masco.com](http://www.masco.com)

#### European Water Label Scheme

Products within the Heritage range are accredited by the European Water Label Scheme therefore meeting industry standards for water efficiency. For a full list of accredited Heritage products and for more information please visit [www.europeanwaterlabel.eu](http://www.europeanwaterlabel.eu)

## Useful Information & Guarantees

### FURNITURE

**Our freestanding furniture** is produced with a painted MDF.

**WC seats** and hinges must be regularly maintained and correctly cleaned using non-corrosive or abrasive cleaning products.

**Worktops** are supplied in varying lengths. Please measure and select carefully. Please also take care when cutting worktops; worktops are not made from solid wood and by cutting them you will expose the edge.

**Wall mounted furniture** in our range is not freestanding and is designed to be wall-mounted.



#### HERITAGE BATHROOMS GUARANTEES

At Heritage Bathrooms, we want to make things as easy as possible for our customers. That's why we design products that are easy to fit and use, and that are quality tested to make sure they won't let you down.

It's also why we offer solid guarantees, effective from the date of purchase, so that in the unlikely event of something going wrong, you have the peace of mind that the problem will be sorted easily.

#### OUR GUARANTEES ARE AS FOLLOWS:

##### Sanitaryware

Lifetime† and 1 year labour\*

##### Baths

Lifetime† and 1 year labour\*

##### Furniture and Worktops

5 years and 1 year labour\*

##### Taps and Mixers\*

10 years parts and 1 year labour. Taps and Mixers purchased on or after 1st April 2021 apply for 10 year guarantee.

\*Plating finishes such as Vintage Gold, Brushed Brass, Brushed Nickle and Matt Black 3 year finish cover, as outlined above.

##### Showers and Mixer Shower Valves\*

5 years parts and 1 year labour\*

##### Heated Towel Rails\*

5 years parts and 1 year labour\*

Bath Panels, Bath & Shower

##### Screens and Cistern Fittings\*

5 years parts and 1 year labour\*

##### Washstands\*

5 years parts and 1 year labour\*

##### Brass Accessories, Wastes & Extras,

##### Standpipes, Shrouds and Cistern Levers\*

5 years parts only.

##### Illuminated Mirrors

5 years parts only.

##### WC Seats and Stainless Steel Accessories

2 years parts only.



\*Labour is provided by an approved engineer or appointed representative. The guarantee only applies to products with a manufacturing fault. There will be a call out charge for any incidents where no fault has been found with the product, or if the issue is due to poor installation or maintenance.

†Lifetime means 25 years.

### FURNITURE FINISHES

Our furniture is available in a choice of painted finishes. While we endeavour to ensure consistency, you may see some slight variation in the colour.

Our coloured finish furniture has the following Pantone references: Maritime Blue 2188U, Classic Green 5535U. Our RAL references are 7047 for Dove Grey, 7016 for Graphite, 9010 for Chantilly and 5011 for Midnight Blue.

#### Terms and conditions of sale

Heritage do not sell direct to the consumer and as such your terms and conditions of sale are with the retailer where you purchased our products. Heritage Bathrooms reserve the right to amend retail prices at any time. We recommend you discuss pricing with your chosen specialist supplier. All prices in this brochure are recommended retail prices and include VAT at 20%. In the event of a change to the VAT rate, prices will change accordingly.

All of our products are covered by a guarantee. Most include both parts and labour (so we'll send an engineer to fix the problem as part of the warranty). Please note that guarantees are only valid with proof of purchase.

Our guarantees apply to products in domestic use. Any products in commercial use carry a guarantee of 1 year. See [www.heritagebathrooms.com/warranty](http://www.heritagebathrooms.com/warranty) for more information.

#### Register now for additional peace of mind

Register your product with us now and, if you do have any queries after installation, we'll be able to identify your product and give you the best advice quickly.

To register your product, simply go online at <https://www.heritagebathrooms.com/service-centre/product-registration>

## Index

<b>A</b>	<b>Bath Panels</b>	120	<b>H</b>		
<b>Accessories</b>			<b>Handles</b>	76	
Chancery	166	<b>Bath Screen</b>	116		
Clifton	168			<b>Heated Towel Rails</b>	
Holborn	170	<b>Bottle Trap</b>	155	Cabot	177
Lullington	172			Clifton	176
Wire baskets	173	<b>C</b>		Portland	176
Bath rack	173	<b>Cast Iron Baths</b>			
Toilet brushes	173	Buckingham	102	<b>Heated Towel Rail Vavles</b>	177
		Devon	103		
		Essex	103	<b>Illuminated Mirrors</b>	
<b>B</b>				Amberley	161
<b>Basins</b>		<b>Cast Iron Bath Feet</b>		Kingston	162
Berkhampsted	89	Buckingham	104	Newick	160
Chiswick	89	Devon	104	Stanmer	163
Dorchester	84	Grand Imperial	104		
Granley	86	Heritage	104	<b>O</b>	
Hatton	88	Imperial	104	<b>Ornate Brackets</b>	156
Kirkham	66				
Redford	89	<b>Cistern Levers</b>	97	<b>S</b>	
Stamford	87			<b>Statement Acrylic Baths</b>	
		<b>F</b>		Alderley	109
<b>Baths</b>		<b>Fitted Baths</b>	114	Holywell	108
Alderley	109			Hylton	108
Buckingham	102	<b>Freestanding Acrylic Baths</b>		Osterly	109
Derrymore	112	Derrymore	112	Wenlock	109
Devon	103	Edvin	110		
Edvin	110	Grantham	112	<b>Showering</b>	
Essex	103	Lydford	110	Avenbury	125
Grantham	112	Oban	111	Dartmouth	128
Holywell	108	Orford	112	Dawlish	131
Hylton	108	Perth	111	Glastonbury	135
Lydford	110	Pomeroy	110	Hartlebury	139
Oban	111	Tilbury	113	Salcombe	144
Orford	112			Trinity	148
Osterley	109	<b>Furniture</b>			
Pomeroy	110	Broughton	64		
Perth	111	Caversham	66		
Tilbury	113	Lynton	70		
Wenlock	109	Wilton	72		

## Index

<b>T</b>	<b>W</b>	<b>WC Seats</b>	96
<b>Taps</b>	<b>Washstands</b>	<b>Worktops</b>	74
Dartmouth	84		
Dawlish	130	<b>Wastes</b>	154
Glastonbury	134		
Hartlebury	138	<b>WCs</b>	
Salcombe	142	Clinton	95
Trinity	146	Dorchester	92
		Granley	93
		Hatton	95
		Stamford	94



---

*Plan your bathroom here*

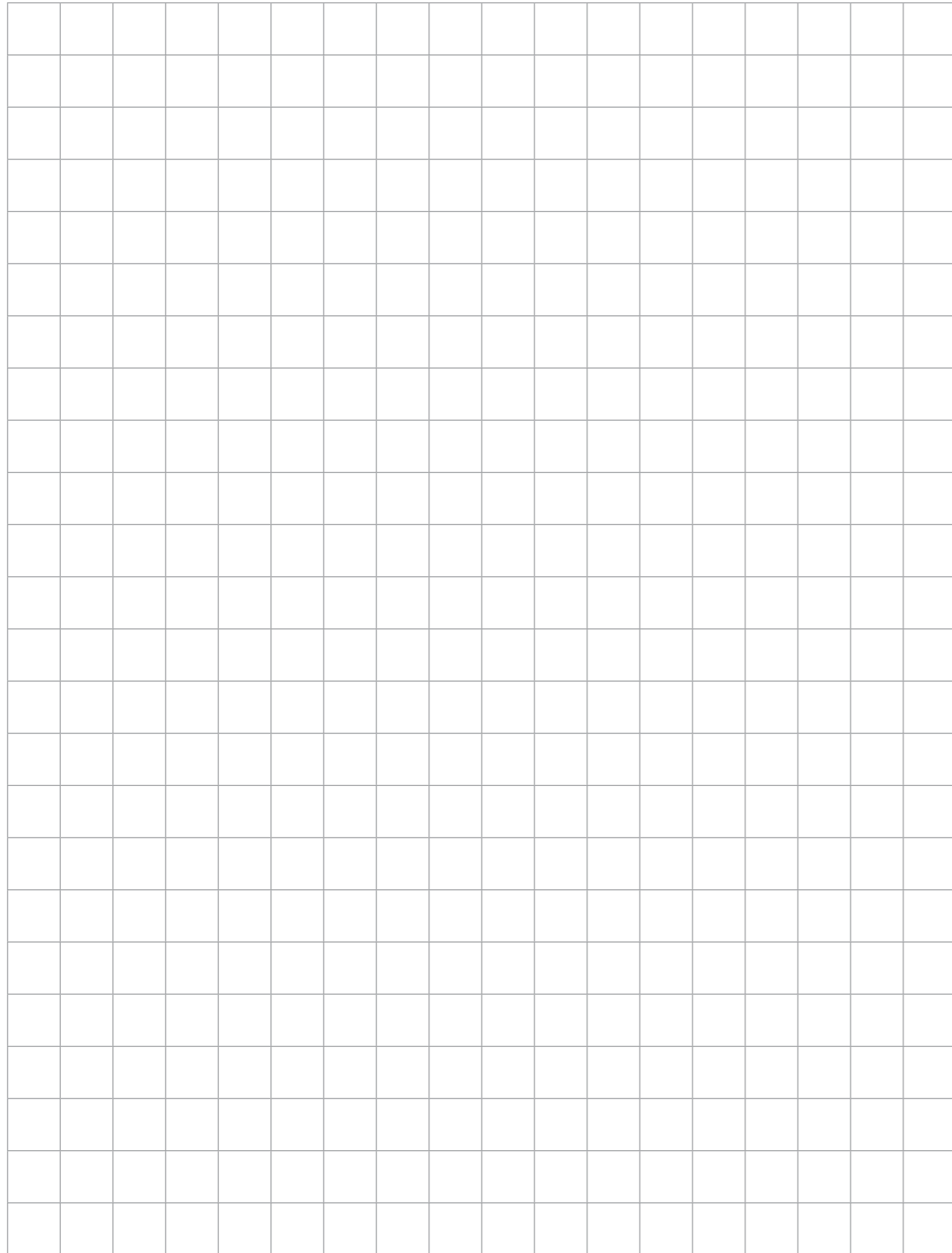

---

*Plan your bathroom here*

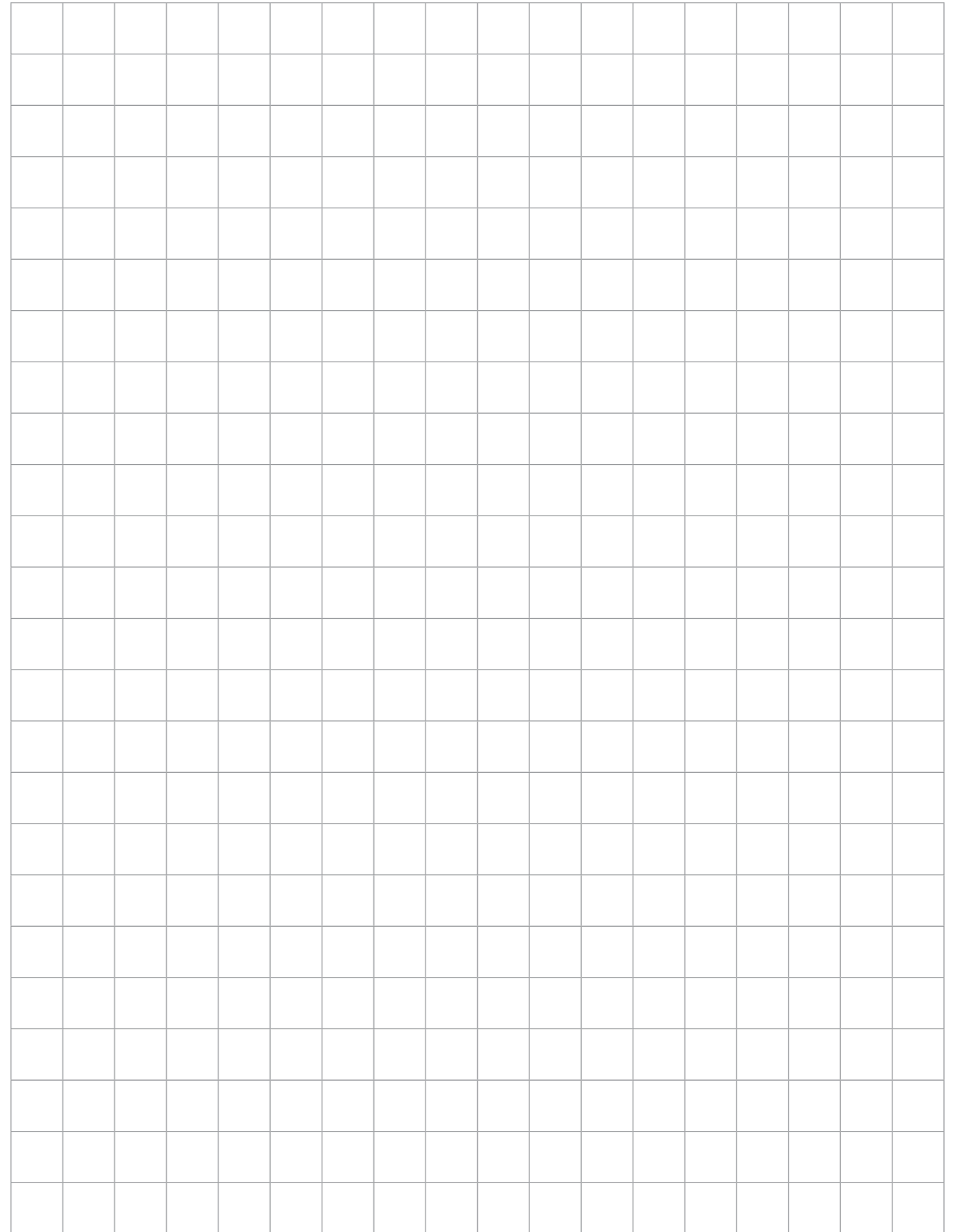

*Plan your bathroom here*





### Sales & General Enquiries

Tel: 0330 026 8501

Fax: 0844 701 8502

Email: [salesorders@heritagebathrooms.com](mailto:salesorders@heritagebathrooms.com)

### Customer Services

Tel: 0330 026 8503

Fax: 0844 701 8504

Email: [enquire@heritagebathrooms.com](mailto:enquire@heritagebathrooms.com)

**HERITAGE<sup>®</sup>**  
BATHROOMS



Printed April 2023

Heritage Bathrooms, Birch Coppice Business Park, Dordon, Tamworth B78 1SG

All rights reserved. No part of this work may be reproduced, utilised or stored in any form or by any means without written permission from Heritage Bathrooms.

© Registered trademark of Heritage Bathrooms. E&OE prices are correct at time of printing.